

Distributed By

Fiedler
Scientific
Instruments

info@pristroje.cz

info@lab-eu.com

(+420) 541 222 795

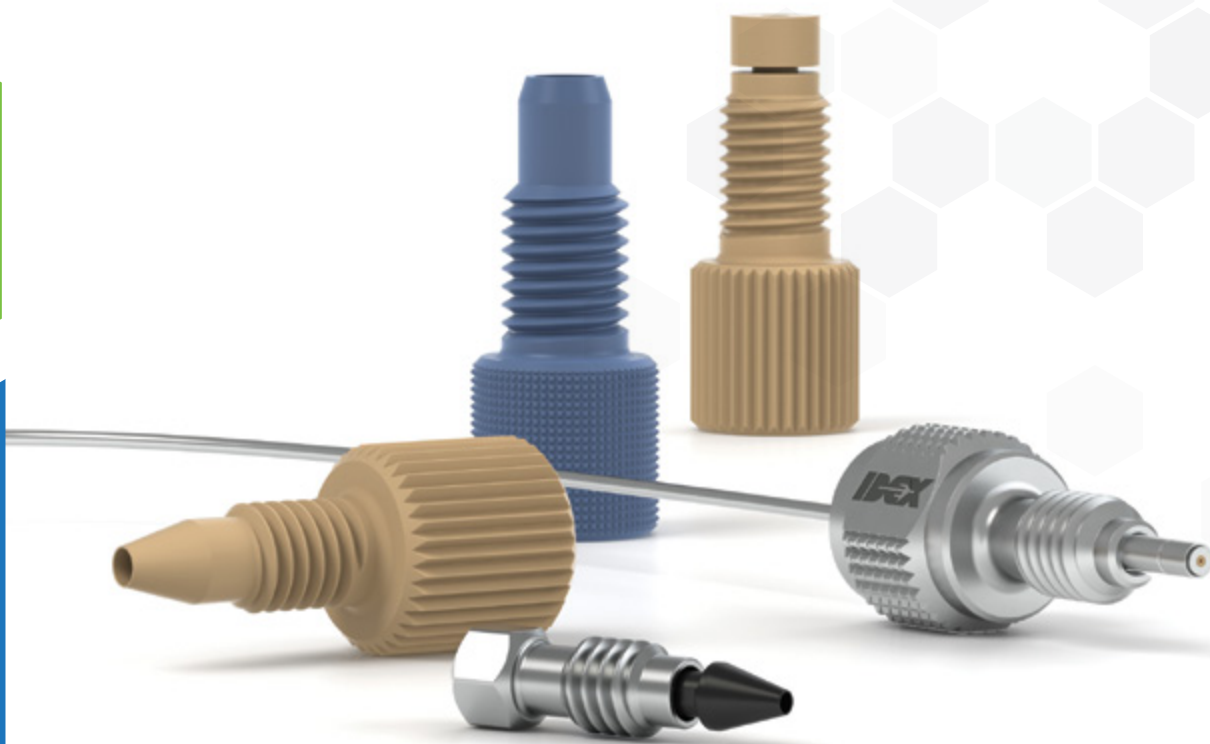

FITTINGS

We offer a wide and diverse selection of fittings to meet your system requirements. A “fitting” refers to a complete product ready to assemble and connect tubing into a part. This could be a one-piece connector or a nut and ferrule packaged together. A “Nut” indicates the male or female threaded product sold separately, and a “Ferrule” is sold separately when indicated in the description. For your convenience we ship most Fittings and Ferrules in 10-packs. We are dedicated to providing the most reliable, proven products on the market. We have implemented more stringent testing protocols and a generous safety margin to our ratings to ensure your safety.

32 CONED FITTINGS

39 FLAT-BOTTOM FITTINGS

48 UHPLC CONNECTION SYSTEMS — MARVELXACT™ & MARVELX™

52 FITTINGS TOOLS

58 LARGE BORE FITTINGS

59 VHP FITTINGS

63 FITTINGS KITS

 NOTE

All testing is performed with water at room temperature unless otherwise specified. Please contact IDEX Health & Science directly for further details. Results may vary depending on the material of the receiving port and tubing, actual tubing diameters (with stated tolerances), temperature and solvents used. If a pressure range is listed for a product's specification, the pressure rating depends on the tubing material used. The lower end of the range will represent testing performed on softer tubing such as FEP, and the higher end of the range will represent testing performed on harder tubing such as Stainless Steel. For more detail, please see the product specification sheets on our website, www.idex-hs.com, or contact us directly.

 APPLICATION NOTE

What Threads Do I Have?

Hold your fitting over the thread silhouettes below to identify the threads.

U.S. CUSTOMARY THREADS

6-40



6-32



10-32



1/4-28



5/16-24



1/2-20



METRIC THREADS

M4 x 0.7



M6 x 1





Stainless Steel Fittings

NOTE

- Do not use metal fittings in plastic ports, as this can damage the port.
- The recommended torque to tighten these fittings is 20 in-lbs (2.25 N·m).

These 316 Stainless Steel Fittings are rated to 20,000 psi (1,380 bar) when wrench tightened. Choose IDEX Health & Science standard fittings, or select from the Common Valve Fittings or other manufacturer-compatible offerings.

Standard Stainless Steel Fittings

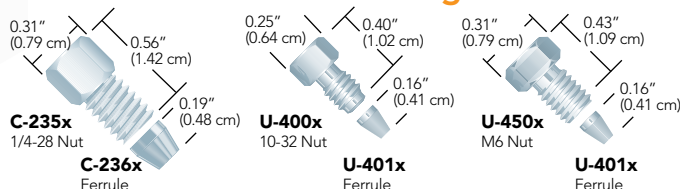

Common Valve Fittings

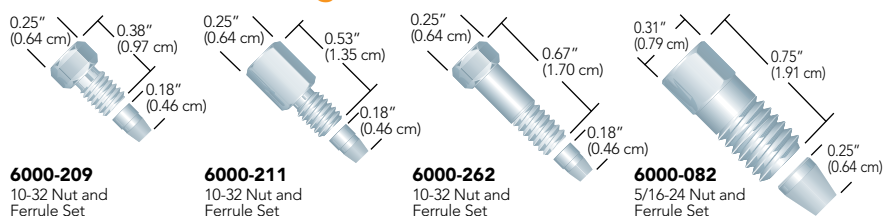

Beckman® Compatible Fittings

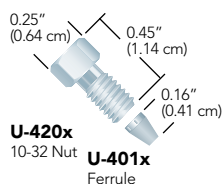

VICI® (Valco) Compatible Fittings

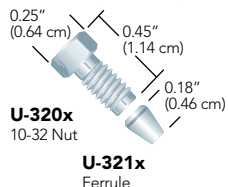

| Part No. | Description | Port | Pressure Rating | Head Style | Material | Qty. |
|--|--|-------------------|------------------------|------------|----------|-------|
| STANDARD STAINLESS STEEL FITTINGS | | | | | | |
| C-235x | Nut for 1/8" OD Tubing | 1/4-28 Coned | 20,000 psi (1,380 bar) | 5/16" Hex | SST | 10-pk |
| C-236x | Ferrule for 1/8" OD Tubing | 1/4-28 Coned | 20,000 psi (1,380 bar) | — | SST | 10-pk |
| U-400x | Nut for 1/16" OD Tubing | 10-32 Coned | 20,000 psi (1,380 bar) | 1/4" Hex | SST | 10-pk |
| U-401x | Ferrule for 1/16" OD Tubing | 10-32 or M6 Coned | 20,000 psi (1,380 bar) | — | SST | 10-pk |
| U-450x | Nut for 1/16" OD Tubing | M6 Coned | 20,000 psi (1,380 bar) | 5/16" Hex | SST | 10-pk |
| COMMON VALVE FITTINGS | | | | | | |
| 6000-082 | Fitting for 1/8" OD Tubing | 5/16-24 Coned | 20,000 psi (1,380 bar) | 5/16" Hex | SST | ea. |
| 6000-083 | Ferrule for 1/8" OD Tubing | 5/16-24 Coned | 20,000 psi (1,380 bar) | — | SST | 5-pk |
| 6000-209 | Fitting for 1/16" OD Tubing | 10-32 Coned | 20,000 psi (1,380 bar) | 1/4" Hex | SST | 10-pk |
| 6000-210 | Ferrule for 1/16" OD Tubing | 10-32 Coned | 20,000 psi (1,380 bar) | — | SST | 10-pk |
| 6000-211 | Fitting for 1/16" OD Tubing, Long | 10-32 Coned | 20,000 psi (1,380 bar) | 1/4" Hex | SST | 10-pk |
| 6000-262 | Fitting for 1/16" OD Tubing, Extra Long | 10-32 Coned | 20,000 psi (1,380 bar) | 1/4" Hex | SST | 10-pk |
| MANUFACTURER COMPATIBLE FITTINGS | | | | | | |
| U-320x | Nuts for 1/16" OD Tubing, Valco/VICI Compatible | 10-32 Coned | 20,000 psi (1,380 bar) | 1/4" Hex | SST | 10-pk |
| U-321x | Ferrule for 1/16" OD Tubing, Valco/VICI Compatible | 10-32 Coned | 20,000 psi (1,380 bar) | — | SST | 10-pk |
| U-410x | Nuts for 1/16" OD Tubing, Waters Compatible | 10-32 Coned | 20,000 psi (1,380 bar) | 5/16" Hex | SST | 10-pk |



MicroTight® Fittings

- › Comprehensive Fitting System for Connecting Capillary Tubing
- › Made from PEEK Polymer

MicroTight® One-Piece Fittings are designed for use with the NanoPort™ and MicroTight Unions, Adapters and Inline MicroFilters. Specifically made for 360 µm OD tubing, 1/32" OD tubing, or our MicroTight Tubing Sleeves (see page 54), these fittings make superior fingertight connections with capillary tubing. MicroTight Fittings withstand temperatures up to 125 °C.

The MicroTight family also includes a female nut matched with one of five dedicated ferrules for connecting specific tubing ODs.

Use the P-277 Extender Tool to tighten standard micro knurl 6-32 fittings in hard-to-reach places. Tighten micro headless 6-32 fittings with our N-290 Tool. See page 52 for more information.



NOTE

MicroTight fittings and MicroFerrules

While the MicroTight Female Nuts may be used with any of the separate MicroFerrules, the MicroFerrules themselves are port-specific and are thus not interchangeable. Additionally, the one-piece MicroTight fittings are also port-specific and should not be exchanged.



F-1245x
Standard Head Fitting
for use with
360 µm OD tubing

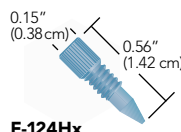

F-124Hx
Headless Fitting
for use with
360 µm OD tubing

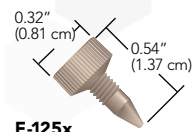

F-125x
Standard Head Fitting
for use with
MicroTight Sleeves



F-125Hx
Headless Fitting
for use with
MicroTight Sleeves

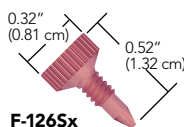

F-1265x
Standard Head Fitting
for use with 1/32" OD tubing

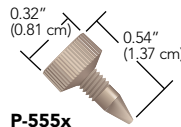

P-555x
Standard Head Plug

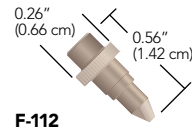

F-112
MicroFerrule for
1/32" OD tubing

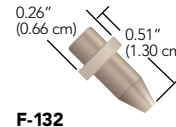

F-132
MicroFerrule for
1/16" OD tubing

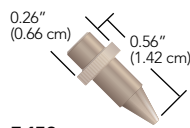

F-152
MicroFerrule for
360 µm OD tubing

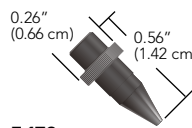

F-172
MicroFerrule for
0.025" OD tubing

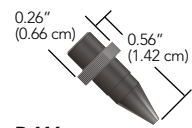

P-116
MicroFerrule Plug

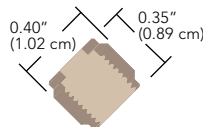

P-416
Female Nut
5/16-24 internal threads



P-416BLK
Female Nut
5/16-24 internal threads



P-416G
Female Nut
5/16-24 internal threads



RELATED PRODUCTS

- › Connectors for Capillary Tubing can be found on page 70.
- › Very High Pressure fittings for capillary tubing can be found on page 60.
- › Capillary tubing is featured on page 16.

| Part No. | Description | Port | Pressure Rating | Head Style | Material | Qty. |
|--------------------------------------|--|---------------|-------------------------------|----------------------|--------------|-------|
| MICROTIGHT FITTINGS | | | | | | |
| F-124Hx | MicroTight Fitting for 360 µm OD Tubing | 6-32 Coned | 5,000 psi (345 bar) | Micro Headless Knurl | PEEK Blue | 10-pk |
| F-1245x | MicroTight Fitting for 360 µm OD Tubing | 6-32 Coned | 5,000 psi (345 bar) | Standard Micro Knurl | PEEK Blue | 10-pk |
| F-125Hx | MicroTight Fitting for MicroTight Tubing Sleeves | 6-32 Coned | 4,000 psi (276 bar) | Micro Headless Knurl | PEEK Natural | 10-pk |
| F-125x | MicroTight Fitting for MicroTight Tubing Sleeves | 6-32 Coned | 4,000 psi (276 bar) | Standard Micro Knurl | PEEK Natural | 10-pk |
| F-1265x | MicroTight Fitting for 1/32" OD Tubing | 6-32 Coned | 5,000 psi (345 bar) | Standard Micro Knurl | PEEK Red | 10-pk |
| P-555x | MicroTight Plug | 6-32 Coned | 5,000 psi (345 bar) | Standard Micro Knurl | PEEK Natural | 10-pk |
| MICROFERRULES AND FEMALE NUTS | | | | | | |
| F-112 | MicroFerrule for 1/32" OD Tubing | 5/16-24 Coned | 5,000 psi (345 bar) | — | PEEK Natural | ea. |
| F-132 | MicroFerrule for 1/16" OD Tubing | 5/16-24 Coned | 5,000 psi (345 bar) | — | PEEK Natural | ea. |
| F-152 | MicroFerrule for 360 µm OD Tubing | 5/16-24 Coned | 5,000 psi (345 bar) | — | PEEK Natural | ea. |
| F-152BLK | MicroFerrule for 360 µm OD Tubing | 5/16-24 Coned | 5,000 psi (345 bar) | — | PEEK Black | ea. |
| F-172 | MicroFerrule for MicroTight Tubing Sleeves | 5/16-24 Coned | 4,000 psi (276 bar) | — | PEEK Black | ea. |
| P-116 | MicroFerrule Plug | 5/16-24 Coned | 5,000 psi (345 bar) | — | PEEK Black | ea. |
| P-416 | MicroTight Female Nut | 5/16-24 Coned | 4,000–5,000 psi (276–345 bar) | Female Knurl | PEEK Natural | ea. |
| P-416BLK | MicroTight Female Nut | 5/16-24 Coned | 4,000–5,000 psi (276–345 bar) | Female Knurl | PEEK Black | ea. |
| P-416G | MicroTight Female Nut | 5/16-24 Coned | 4,000–5,000 psi (276–345 bar) | Female Knurl | PEEK Green | ea. |



Two-Piece Fingertight Fittings

- › Designed to connect tubing to 10-32 coned ports
- › Ferrules available for directly connecting 1/16", 1/32", 360 µm, or 190 µm OD tubing
- › Economical, replace only the ferrule



APPLICATION NOTE

Some Fingertight Nuts feature wings in addition to a knurled head, which provide more leverage when tightening the fitting into a receiving port. Choose our single or double-winged design.

Please Note: customers can use the standard knurl head fittings with our tightening tools found on page 52.

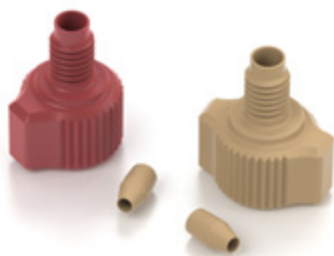

Two-Piece Fingertight Fittings feature a separate ferrule. Use a standard knurled head fitting for traditional fingertight applications, or use a fitting with wings built into the head for extra tightening leverage. A stainless steel hex headed fitting can be used for applications where a wrench may be needed for added tightening torque.

The M-215 Conductive Perfluoroelastomer Ferrule is designed for mass spectrometer electrospray applications. Unlike most graphite ferrules, the elastomeric properties of this ferrule let you use it through many tightening/retightening cycles. It also eliminates any possibility of graphite contamination in your system. Like graphite ferrules, you can apply voltage through a metallic port block or metallic nut, allowing voltage to translate to the flow path through the ferrule.

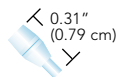

F-148
PCTFE Ferrule
for 190 µm OD tubing

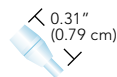

F-151
PCTFE Ferrule
for 360 µm OD tubing

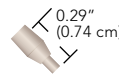

F-113
PEEK Ferrule
for 1/32" OD tubing

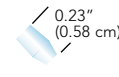

F-142N
ETFE Ferrule
for 1/16" OD tubing

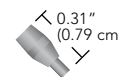

M-215
Conductive
Perfluoroelastomer
Ferrule for 360 µm
OD tubing

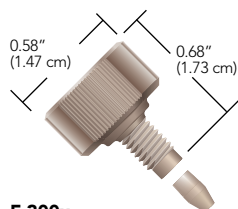

F-300x
10-32 PEEK Double-Winged Nut
with F-142x PEEK Ferrule

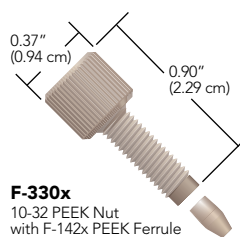

F-330x
10-32 PEEK Nut
with F-142x PEEK Ferrule

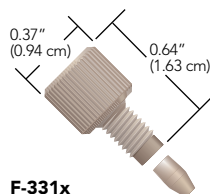

F-331x
10-32 PEEK Nut
with F-142x PEEK Ferrule

| Part No. | Description | Port | Pressure Rating | Head Style | Material | Qty. |
|---|---|-------------|---------------------|----------------|-------------------------------|-------|
| TWO-PIECE FINGERTIGHT FITTINGS (INCLUDES F-142 FERRULES) | | | | | | |
| F-300x | Fingertight Fitting for 1/16" OD Tubing | 10-32 Coned | 6,000 psi (414 bar) | Double Wing | PEEK Natural | 10-pk |
| F-330x | Fingertight Fitting for 1/16" OD Tubing, Long | 10-32 Coned | 6,000 psi (414 bar) | Standard Knurl | PEEK Natural | 10-pk |
| F-331x | Fingertight Fitting for 1/16" OD Tubing | 10-32 Coned | 6,000 psi (414 bar) | Standard Knurl | PEEK Natural | 10-pk |
| REPLACEMENT FERRULES | | | | | | |
| F-113 | Ferrule for 1/32" OD Tubing | 10-32 Coned | 6,000 psi (414 bar) | — | PEEK Natural | ea. |
| F-142 | Ferrule for 1/16" OD Tubing | 10-32 Coned | 6,000 psi (414 bar) | — | PEEK Natural | ea. |
| F-142N | Ferrule for 1/16" OD Tubing | 10-32 Coned | 4,000 psi (276 bar) | — | ETFE Natural | ea. |
| F-148 | Ferrule for 190 µm OD tubing | 10-32 Coned | 6,000 psi (414 bar) | — | PCTFE Natural | ea. |
| F-151 | Ferrule for 360 µm OD Tubing | 10-32 Coned | 6,000 psi (414 bar) | — | PCTFE Natural | ea. |
| M-215 | Conductive Ferrule for 360 µm OD tubing | 10-32 Coned | 1,500 psi (103 bar) | — | Conductive Perfluoroelastomer | ea. |



Two-Piece SealTight™ Fingertight Fittings

- › Several nut lengths and head styles to fit into a variety of applications
- › Designed to connect 1/16" OD tubing to 10-32 coned ports
- › Hold up to 9,000 psi (620 bar)

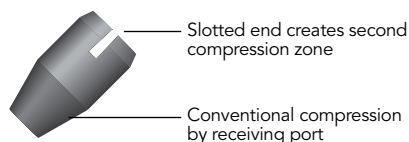

NOTE

Overtightening these fittings on fluoropolymer (e.g., FEP, PFA, and ETFE) tubing can cause the ID of your tubing to collapse.

RELATED PRODUCTS

- › Find tightening tools for these fittings on page 52.
- › Try the F-350x FlushNut™ for the ultimate streamline design.

The dual compression created by the specially designed nut and ferrule enables our SealTight™ Fittings system to outperform standard finger tightened fittings. The forward cone of the SealTight Ferrule provides gripping power and a leak-free seal via conventional compression by the receiving port. The slotted end creates the second compression zone in conjunction with a SealTight Nut. All SealTight Nuts are for use with 1/16" OD tubing and are designed to be used with the F-192x Ferrule. A wide variety of fitting head styles are available for various space constraints.

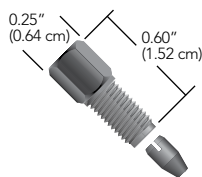

F-193x
10-32 Short PEEK Hex Head Nut, with F-192x Ferrule

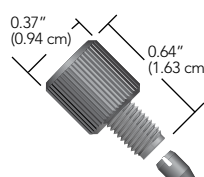

F-195x
10-32 Short PEEK Nut, with F-192x Ferrule

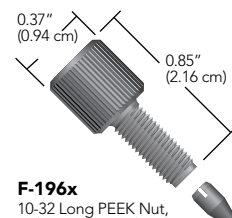

F-196x
10-32 Long PEEK Nut, with F-192x Ferrule

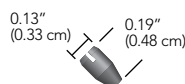

F-192x
SealTight Ferrule, for 1/16" OD tubing

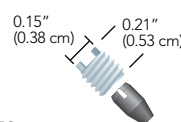

F-350x
10-32 Stainless Steel FlushNut, with F-192x Ferrule

| Part No. | Description | Port | Pressure Rating | Head Style | Material | Qty. |
|---|---|-------------------|-------------------------------|----------------|------------|-------|
| SEALTIGHT TWO-PIECE FITTINGS (INCLUDES F-192 FERRULES) | | | | | | |
| F-193x | SealTight Fitting for 1/16" OD Tubing, Short | 10-32 Coned | 7,000–9,000 psi (483–620 bar) | 1/4" Hex | PEEK Black | 10-pk |
| F-195x | SealTight Fitting for 1/16" OD Tubing, Short | 10-32 Coned | 7,000–9,000 psi (483–620 bar) | Standard Knurl | PEEK Black | 10-pk |
| F-196x | SealTight Fitting for 1/16" OD Tubing, Long | 10-32 Coned | 7,000–9,000 psi (483–620 bar) | Standard Knurl | PEEK Black | 10-pk |
| F-287x | SealTight Fitting for 1/16" OD Tubing, Long | 10-32 Coned | 7,000–9,000 psi (483–620 bar) | Knurl-1/4" Hex | PEEK Black | 10-pk |
| F-350x | SealTight Fitting for 1/16" OD Tubing, FlushNut | 10-32 Coned | 7,000–9,000 psi (483–620 bar) | FlushNut | SST | 10-pk |
| REPLACEMENT FERRULES | | | | | | |
| F-192x | SealTight Ferrule for 1/16" OD Tubing | 10-32 or M6 Coned | 7,000–9,000 (483–620 bar) | — | PEEK/Black | 10-pk |



NanoTight™ Fittings & Sleeves

- › For connecting 1/16" OD or capillary tubing using tubing sleeves to standard 10-32 coned ports
- › Multiple nut styles available
- › Nuts manufactured from PEEK polymer, ferrules manufactured from ETFE



RELATED PRODUCTS

- › Find tightening tools for these head styles on page 52.
- › NanoTight Tubing sleeves start on page 54.

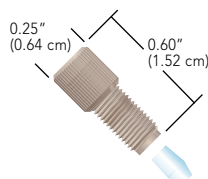

F-333Nx
Short Headless Nut
with F-142Nx Ferrule

NanoTight™ Fittings and Sleeves are designed to connect 70 µm–1 mm OD capillary tubing to any standard 10-32 coned port normally intended for 1/16" OD tubing using the NanoTight Tubing Sleeves on page 54. The fittings can also be used to connect any 1/16" OD tubing. The ETFE ferrule material is softer than PEEK, making it a good candidate for connecting thin walled semi-rigid tubing such as FEP and ETFE into 10-32 ports with minimal constricting to the inner diameter.

Select from our expansive line of PEEK NanoTight Fittings, featuring several head style and length options. Each 10-pack of nuts includes ten ETFE F-142Nx ferrules.

| Part No. | Description | Port | Pressure Rating | Head Style | Material (Nut/Ferrule) | Qty. |
|--|--|-------------|---------------------|----------------|---------------------------|-------|
| NANOTIGHT FITTINGS (INCLUDES F-142N FERRULES) | | | | | | |
| F-333Nx | NanoTight Fitting for 1/16" OD Tubing and NanoTight Sleeves, Short | 10-32 Coned | 4,000 psi (276 bar) | Headless Knurl | PEEK Natural/ETFE Natural | 10-pk |
| REPLACEMENT FERRULES | | | | | | |
| F-142Nx | NanoTight Ferrule for 1/16" OD Tubing and NanoTight Sleeves | 10-32 Coned | 4,000 psi (276 bar) | — | ETFE Natural | 10-pk |

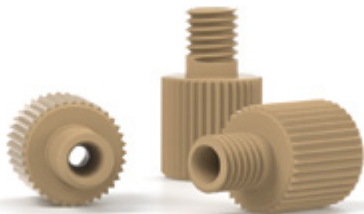

LiteTouch® Fittings

- › Helps prevent twisting of polymer tubing
- › High pressure with fingertight convenience
- › Options available for 1/32", 1/16", or 1/8" OD tubing

LITETOUCH FITTINGS SYSTEMS

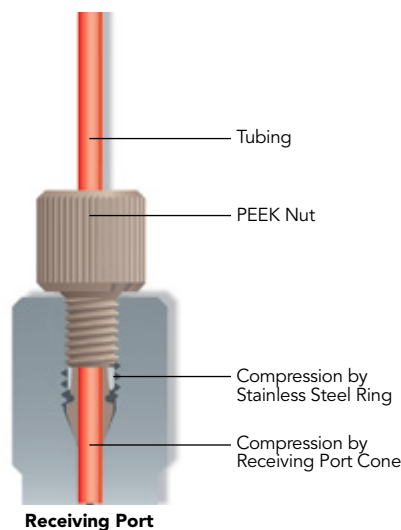

The LiteTouch® Fittings System grips tubing at two compression points (see diagram), holding to high pressures with Fingertight convenience. It also prevents polymer tubing from twisting, a potential problem when using standard Fingertight fittings. LiteTouch Fittings are available for use with 1/32", 1/16", or 1/8" OD tubing sizes, and for 10-32 or 1/4-28 coned ports.

For those space-limited applications where nut heads interfere with each other, try the FlushNut™ Fittings. (FlushNut Fittings require a tightening tool. Please see page 52 for more information about these products.)

To avoid collapsing the ID of your tubing, the LiteTouch system can be used on hard tubing only, such as stainless steel and PEEK polymer tubing. The LiteTouch Ferrule System is not recommended for repeated use in plastic ports.

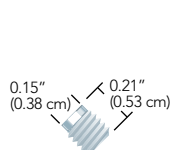

F-354x
10-32 Stainless Steel FlushNut for 1/32" and 1/16" OD tubing

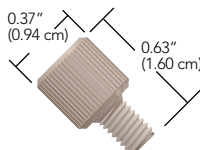

LT-110x
10-32 PEEK Nut for 1/32" and 1/16" OD tubing

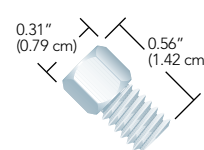

C-235x
1/4-28 Stainless Steel Nut for 1/8" OD tubing

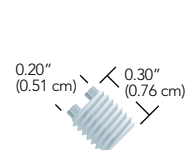

F-364x
1/4-28 Stainless Steel FlushNut for 1/8" OD tubing

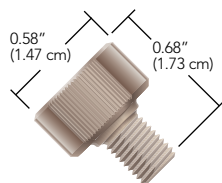

LT-210x
1/4-28 PEEK Double-Winged Nut for 1/8" OD tubing



LT-132x
PEEK Ferrule with Stainless Steel Lock Ring for 1/32" OD tubing

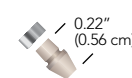

LT-100x
PEEK Ferrule with Stainless Steel Lock Ring for 1/16" OD tubing

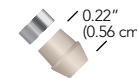

LT-200x
PEEK Ferrule with Stainless Steel Lock Ring for 1/8" OD tubing

RELATED PRODUCTS

- › The stainless steel nuts on page 61 can also be used with the LiteTouch ferrules on this page.

| Part No. | Description | Port | Pressure Rating | Head Style | Material | Qty. |
|---------------------------|--|--------------|---------------------|----------------|------------------|-------|
| LITETOUCH NUTS | | | | | | |
| C-235x | LiteTouch Nut for 1/8" OD Tubing | 1/4-28 Coned | 4,500 psi (310 bar) | 5/16" Hex | SST | 10-pk |
| F-354x | LiteTouch Nut for 1/16" or 1/32" OD Tubing, FlushNut | 10-32 Coned | 5,000 psi (345 bar) | FlushNut | SST | 10-pk |
| F-364x | LiteTouch Nut for 1/8" OD Tubing, FlushNut | 1/4-28 Coned | 4,500 psi (310 bar) | FlushNut | SST | 10-pk |
| LT-110x | LiteTouch Nut for 1/16" or 1/32" OD Tubing | 10-32 Coned | 5,000 psi (345 bar) | Standard Knurl | PEEK Natural | 10-pk |
| LT-210x | LiteTouch Nut for 1/8" OD Tubing | 1/4-28 Coned | 4,500 psi (310 bar) | Double Wing | PEEK Natural | 10-pk |
| LITETOUCH FERRULES | | | | | | |
| LT-100x | LiteTouch Ferrule for 1/16" OD Tubing | 10-32 Coned | 5,000 psi (345 bar) | — | PEEK Natural/SST | 10-pk |
| LT-132x | LiteTouch Ferrule for 1/32" OD Tubing | 10-32 Coned | 5,000 psi (345 bar) | — | PEEK Natural/SST | 10-pk |
| LT-200x | LiteTouch Ferrule for 1/8" OD Tubing | 1/4-28 Coned | 4,500 psi (310 bar) | — | PEEK Natural/SST | 10-pk |

* When used with a stainless steel 10-32 nut from page 61.



Super Flangeless™ Fittings

- › Highest pressure holding flat-bottom fitting system we offer
- › Eliminates loosening of fittings due to tubing twist
- › Excellent for Tubing Assemblies
- › Holds tight even through vibration

ASSEMBLY HINT

Make sure the locking ring is oriented correctly! The flattened end of the ring should face towards the nut with the narrow end of the ferrule towards the ring.

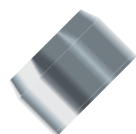

Enlarged to show detail

SUPER FLANGELESS FITTINGS SYSTEM

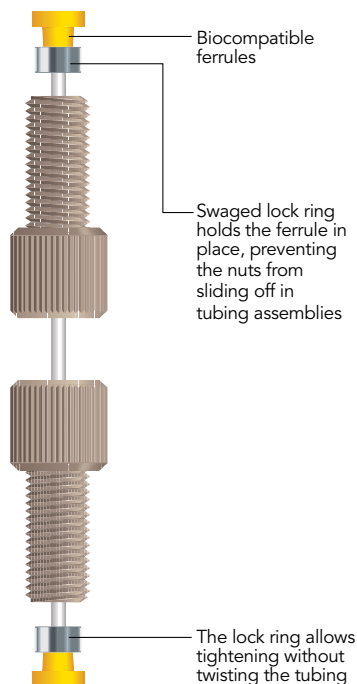

Our Super Flangeless™ Fittings provide the highest pressure holding capability in a flat-bottom fitting system that we offer. Our unique design eliminates loosening of fittings due to tubing twist and holds tight even through vibration. Our high pressure fittings are excellent for tubing assemblies and those times when connections need to be broken frequently.

6-40 & 6-32 options (for 1-16" OD tubing)

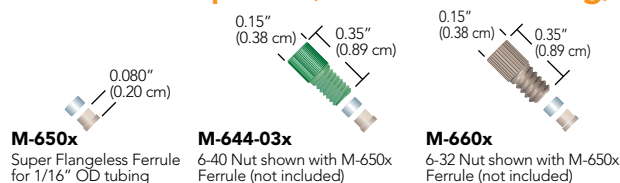

10-32 options (for 1-16" OD tubing)

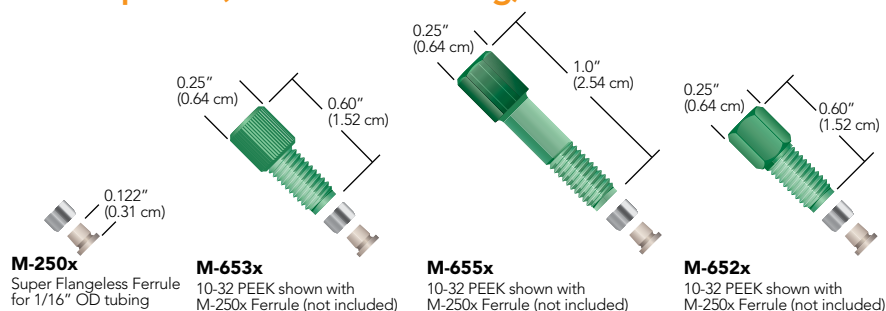

Ferrules for M6x1, 1/4-28, 5/16-24

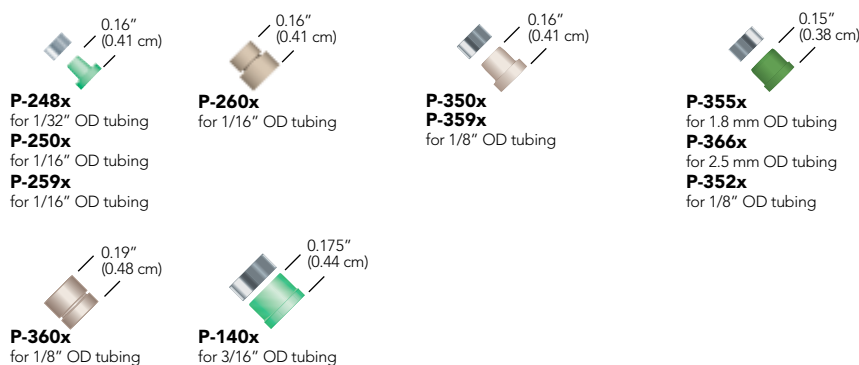

Super Flangeless™ Fittings (Cont.)

M6x1, 1/4-28, 5/16-24 Options for 1/32"–3/16" OD Tubing

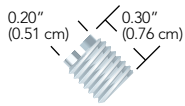

F-356x
(M6X1, ≤ 1/16" OD Tubing)
F-364x
(1/4-28, > 1/16" OD Tubing)

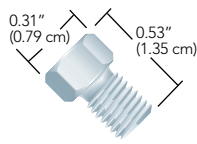

LT-105x
(1/4-28, ≤ 1/16" OD Tubing)
C-235x
(1/4-28, > 1/16" OD Tubing)

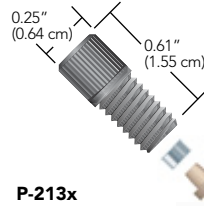

P-213x
(M6X1, ≤ 1/16" OD Tubing)
P-337x
(M6X1, > 1/16" OD Tubing)
P-232x
(1/4-28, ≤ 1/16" OD Tubing)
P-336x
(1/4-28, > 1/16" OD Tubing)

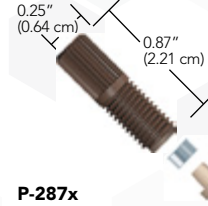

P-287x
(1/4-28, ≤ 1/16" OD Tubing)
P-387x
(1/4-28, > 1/16" OD Tubing)

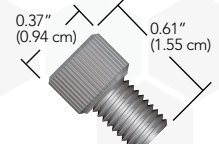

P-219x
(M6X1, ≤ 1/16" OD Tubing)
P-319x
(M6X1, > 1/16" OD Tubing)
LT-115x
(1/4-28, ≤ 1/16" OD Tubing)

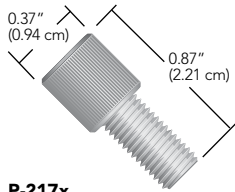

P-217x
(M6X1, ≤ 1/16" OD Tubing)
P-317x
(M6X1, > 1/16" OD Tubing)
P-246x, P-255x, P-281x
(1/4-28, ≤ 1/16" OD Tubing)
P-331x, P-381x
(1/4-28, > 1/16" OD Tubing)

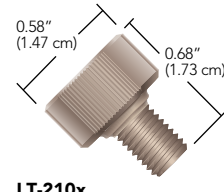

LT-210x
(1/4-28, > 1/16" OD Tubing)

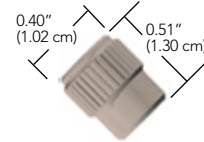

P-420x
(1/4-28, ≤ 1/16" OD Tubing)
F-156x
(1/4-28, > 1/16" OD Tubing)

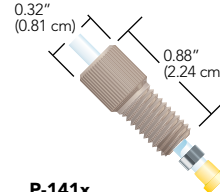

P-141x
(5/16-24, ≤ 1/16" OD Tubing)
P-137x
(5/16-24, 3/16" OD Tubing)

One-Piece Super Flangeless™ Fittings

- › All-PEEK construction
- › For 1/16" OD and 1/8" OD tubing
- › M6x1 and 1/4-28 options
- › Finger tight (2–3 in-lbs / 0.23–0.34 N·m)
- › Extremely easy to use
- › Reusable one piece design that requires no swaging

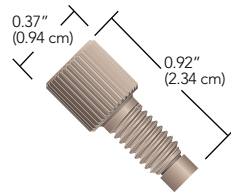

P-329x
M6X1, for 1/8" OD Tubing
P-249x
1/4-28, for 1/16" OD Tubing
P-349x
1/4-28, for 1/8" OD Tubing

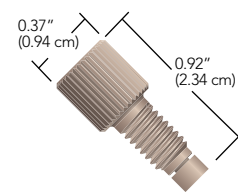

P-229x
M6X1, for 1/16" OD Tubing

Super Flangeless Tubing OD / Thread Comparison

| | 1/32" | 1/16" | 1.8 MM | 2.5 MM | 1/8" | 3/16" |
|----------------|-------|-------|--------|--------|------|-------|
| 6-40 | | ✓ | | | | |
| 6-32 | | ✓ | | | | |
| 10-32 | | ✓ | | | | |
| M6x1 | ✓ | ✓ | ✓ | ✓ | ✓ | |
| 1/4-28 | ✓ | ✓ | ✓ | ✓ | ✓ | |
| 5/16-24 | | | | | | ✓ |

Super Flangeless™ and One-Piece Super Flangeless Fittings

| Part No. | Description | Port | Pressure Rating | Head Style | Material | Qty. |
|---|---|--------------------------|------------------------------|----------------|-------------------------|-------|
| SUPER FLANGELESS FERRULES FOR 1/32", 1/16", 1/8", 3/16", 1.8MM, 2.0MM, 2.5MM | | | | | | |
| M-250x | Super Flangeless Ferrule for 1/16" OD Tubing | 10-32 Flat-Bottom | 1,000–5,000 psi (69–345 bar) | — | PEEK Natural/SST | 10-pk |
| M-650x | Super Flangeless Ferrule for 1/16" OD Tubing | 6-32 or 6-40 Flat Bottom | 750–3,750 psi (52–259 bar) | — | PEEK Natural/SST | 10-pk |
| P-248x | Super Flangeless Ferrule for 1/32" OD Tubing | 10-32 Flat-Bottom | 2,500 psi (172 bar) | — | ETFE Green/SST | 10-pk |
| P-250x | Super Flangeless Ferrule for 1/16" OD Tubing | 1/4-28 or M6 Flat Bottom | 2,500 psi (172 bar) | — | PEEK Natural/SST | 10-pk |
| P-259x | Super Flangeless Ferrule for 1/16" OD Tubing | 1/4-28 or M6 Flat Bottom | 1,350 psi (93 bar) | — | ETFE Yellow/SST | 10-pk |
| P-260x | Super Flangeless Ferrule for 1/16" OD Tubing | 1/4-28 or M6 Flat Bottom | 1,850 psi (128 bar) | — | PEEK Natural/SST | 10-pk |
| P-350x | Super Flangeless Ferrule for 1/8" OD Tubing | 1/4-28 Flat Bottom | 2,500 psi (172 bar) | — | PEEK Natural/SST | 10-pk |
| P-352x | Super Flangeless Ferrule for 1/16" OD Tubing | 1/4-28 or M6 Flat Bottom | 2,500 psi (172 bar) | — | PEEK Black/SST | 10-pk |
| P-355x | Super Flangeless Ferrule for 1.8 mm OD Tubing | 1/4-28 or M6 Flat Bottom | 2,500 psi (172 bar) | — | PCTFE Green/SST | 10-pk |
| P-357-2x | Super Flangeless Ferrule for 2.0 mm OD Tubing | M6 Flat Bottom | 5,000 psi (345 bar) | — | PEEK Natural/SST | 10-pk |
| P-359x | Super Flangeless Ferrule for 1/8" OD Tubing | 1/4-28 Flat Bottom | 1,000 psi (69 bar) | — | ETFE Yellow/SST | 10-pk |
| P-360x | Super Flangeless Ferrule for 1/8" OD Tubing | 1/4-28 Flat Bottom | 1,500 psi (102 bar) | — | PEEK Natural/SST | 10-pk |
| P-366x | Super Flangeless Ferrule for 2.5" OD Tubing | 1/4-28 Flat Bottom | 1,000 psi (69 bar) | — | PEEK Natural/SST | 10-pk |
| P-140x | Super Flangeless Ferrule for 3/16" OD Tubing | 5/16-24 Flat Bottom | 500 psi (34 bar) | — | ETFE Green/SST | 10-pk |
| 6-40 AND 6-32 FITTINGS FOR 1/16" OD TUBING | | | | | | |
| M-660x | Super Flangeless Nut for 1/16" OD Tubing | 6-32 Flat Bottom | 750–3,750 psi (52–259 bar) | Micro Headless | PEEK Natural | 10-pk |
| M-644-03x | Super Flangeless Nut for 1/16" OD Tubing | 6-40 Flat Bottom | 750–3,750 psi (52–259 bar) | Micro Headless | PEEK Green | 10-pk |
| 10-32 FITTINGS FOR 1/16" OD TUBING | | | | | | |
| M-652x | Super Flangeless Nut for 1/16" OD Tubing | 10-32 Flat Bottom | 1,000–5,000 psi (69–345 bar) | 1/4" Hex | PEEK Green | 10-pk |
| M-653x | Super Flangeless Nut for 1/16" OD Tubing | 10-32 Flat Bottom | 1,000–5,000 psi (69–345 bar) | Headless Knurl | PEEK Green | 10-pk |
| M-655x | Super Flangeless Nut for 1/16" OD Tubing, Long | 10-32 Flat Bottom | 1,000–5,000 psi (69–345 bar) | 1/4" Hex | PEEK Green | 10-pk |
| M6X1 FITTINGS FOR 1/16" AND 1/32" OD TUBING | | | | | | |
| P-213x | Super Flangeless Nut for 1/16" or 1/32" OD Tubing, Short | M6 Flat Bottom | * | Headless Knurl | PEEK Black | 10-pk |
| P-217x | Super Flangeless Nut for 1/16" or 1/32" OD Tubing | M6 Flat Bottom | * | Standard Knurl | PPS Black | 10-pk |
| P-219x | Super Flangeless Nut for 1/16" or 1/32" OD Tubing, Short | M6 Flat Bottom | * | Standard Knurl | PEEK Black | 10-pk |
| M6X1 FITTINGS FOR 1.8 MM, 2.0 MM, 2.5 MM, 1/8" OD TUBING | | | | | | |
| P-317x | Super Flangeless For >1/16"–≤ 1/8" OD Tubing | M6 Flat Bottom | * | Standard Knurl | PPS Black | 10-pk |
| P-319x | Super Flangeless Nut for 1/8" OD Tubing, Short | M6 Flat Bottom | * | Standard Knurl | PEEK Black | 10-pk |
| P-337x | Super Flangeless For >1/16"–≤ 1/8" OD Tubing, Short | M6 Flat Bottom | * | Headless Knurl | PEEK Black | 10-pk |
| P-357x | Super Flangeless Fitting for 2.0 mm OD Tubing | M6 Flat Bottom | * | Standard Knurl | PEEK Black, Natural/SST | 10-pk |
| 1/4-28 FITTINGS FOR 1/16" AND 1/32" OD TUBING | | | | | | |
| F-356x | Super Flangeless Nut for 1/16" or 1/32" OD Tubing, FlushNut | 1/4-28 Flat Bottom | * | FlushNut | SST | 10-pk |
| LT-105x | Super Flangeless Nut for 1/16" or 1/32" OD Tubing, Short | 1/4-28 Flat Bottom | * | 1/4" Hex | SST | 10-pk |
| LT-115x | Super Flangeless Nut for 1/16" or 1/32" OD Tubing, Short | 1/4-28 Flat Bottom | * | Standard Knurl | PEEK Natural | 10-pk |
| P-232x | Super Flangeless Nut for 1/16" or 1/32" OD Tubing, Short | 1/4-28 Flat Bottom | * | Headless Knurl | PEEK Natural | 10-pk |
| P-246x | Super Flangeless Nut for 1/16" or 1/32" OD Tubing | 1/4-28 Flat Bottom | * | Standard Knurl | PFA Natural | 10-pk |
| P-255x | Super Flangeless Nut for 1/16" or 1/32" OD Tubing | 1/4-28 Flat Bottom | * | Standard Knurl | PEEK Natural | 10-pk |
| P-281x | Super Flangeless Nut for 1/16" or 1/32" OD Tubing | 1/4-28 Flat Bottom | * | Standard Knurl | PPS Natural | 10-pk |
| P-287x | Super Flangeless Nut for 1/16" or 1/32" OD Tubing | 1/4-28 Flat Bottom | * | Headless Knurl | PPS Natural | 10-pk |
| P-420x | Super Flangeless Nut for 1/16" or 1/32" OD Tubing, Female | 1/4-28 Flat Bottom | * | Female Knurl | PEEK Natural | 10-pk |
| 1/4-28 FITTINGS FOR 1.8MM, 2.5 MM, 1/8" OD TUBING | | | | | | |
| C-235x | Super Flangeless Nut for 1/8" OD Tubing | 1/4-28 Flat Bottom | * | 1/4" Hex | SST | 10-pk |
| F-156x | Super Flangeless Nut for 1/8" OD Tubing, Female | 1/4-28 Flat Bottom | * | Female Knurl | PEEK Black | 10-pk |
| F-364x | Super Flangeless Nut for 1/8" OD Tubing, FlushNut™ | 1/4-28 Flat Bottom | * | FlushNut | SST | 10-pk |
| LT-210x | Super Flangeless Nut for 1/8" OD Tubing | 1/4-28 Flat Bottom | * | Double Wings | PEEK Natural | 10-pk |
| P-331x | Super Flangeless Nut for 1/8" OD Tubing | 1/4-28 Flat Bottom | * | Standard Knurl | PEEK Natural | 10-pk |
| P-336x | Super Flangeless Nut for 1/8" OD Tubing, Short | 1/4-28 Flat Bottom | * | Headless Knurl | PEEK Natural | 10-pk |
| P-381x | Super Flangeless Nut for 1/8" OD Tubing | 1/4-28 Flat Bottom | * | Standard Knurl | PPS Natural | 10-pk |
| P-387x | Super Flangeless Nut for 1/8" OD Tubing | 1/4-28 Flat Bottom | * | Standard Knurl | PPS Natural | 10-pk |
| 5/16-24 FITTINGS FOR 1/16", 1/8", 3/16" OD TUBING | | | | | | |
| P-137x | Super Flangeless Fitting for 3/16" OD Tubing | 5/16-24 Flat Bottom | * | Standard Knurl | PEEK Black | 10-pk |
| P-141x | Super Flangeless Fitting for 1/16" OD Tubing | 5/16-24 Flat Bottom | * | Standard Knurl | PEEK Natural | 10-pk |
| ONE-PIECE SUPER FLANGELESS FITTINGS FOR 1/16" AND 1/8" OD TUBING | | | | | | |
| P-229x | One Piece Super Flangeless Fitting for 1/16" OD Tubing | M6 Flat Bottom | 1,000 psi (69 bar) | Standard Knurl | PEEK | 10-pk |
| P-249x | One Piece Super Flangeless Fitting for 1/16" OD Tubing | 1/4-28 Flat Bottom | 1,000 psi (69 bar) | Standard Knurl | PEEK | 10-pk |
| P-329x | One Piece Super Flangeless Fitting for 1/8" OD Tubing | M6 Flat Bottom | 1,000 psi (69 bar) | Standard Knurl | PEEK | 10-pk |
| P-349x | One Piece Super Flangeless Fitting for 1/8" OD Tubing | 1/4-28 Flat Bottom | 1,000 psi (69 bar) | Standard Knurl | PEEK | 10-pk |

* Pressure rating of nut depends on the ferrule used.



VacuTight™ Fittings

- › For 1/16" or 1/8" OD tubing connections into 10-32, 1/4-28, or M6 flat-bottom ports
- › Vacuum Rated to 25 in-Hg (84 kPa)
- › Improve transfer volume consistency

VacuTight Fittings are designed to provide airtight, dependable connections under vacuum and low pressure conditions. Many of the VacuTight Nuts have streamlined profiles for use in systems requiring a large number of connections in a small area. Furthermore, the VacuTight Ferrule's small size ensures sufficient nut/thread engagement, even in shallow ports. These features make VacuTight Fittings ideal for "combichem" high throughput screening, clinical diagnostic, and other automated liquid handling applications.

The configuration of the VacuTight flat-bottom ferrules prevents overcompression and tubing ID reduction that can occur with many coned fittings. The result is more consistent aspirating and dispensing volumes across all system connections.

The VacuTight fittings can also work well in some positive pressure applications. The pressure range for each fitting is listed below and depends upon the tubing used for the connection. Please contact your distributor or IDEX Health & Science for more information. Additionally, please note that some of the VacuTight fittings have changed in color from red to black; however, this color change does not affect product performance.

All VacuTight Nuts must be used exclusively with VacuTight Ferrules.

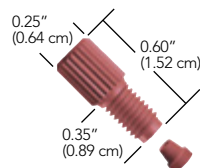

P-844x
PEEK Nut, 10-32
with P-840 Ferrule

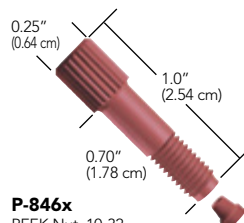

P-846x
PEEK Nut, 10-32
with P-846 Ferrule

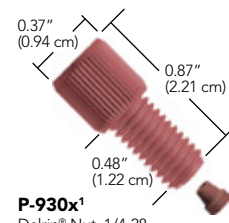

P-930x¹
Delrin® Nut, 1/4-28
with P-840 Ferrule

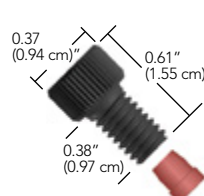

P-945x²
Delrin Nut, M6
with P-940 Ferrule

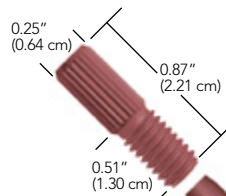

P-946x³
Delrin Nut, 1/4-28
with P-946 Ferrule

¹ The dimensions shown apply to P-930x, P-931x, P-938x, P-942x, and P-948x.

² The dimensions shown apply to P-945x.

³ The dimensions shown apply to P-946x.

| Part No. | Description | Port | Pressure Rating | Head Style | Material | Qty. |
|--|--|--------------------------|---------------------------|----------------|--------------|-------|
| VACUTIGHT FITTINGS (INCLUDES P-840 OR P-940 FERRULES) | | | | | | |
| P-842x | VacuTight Fitting for 1/16" OD Tubing, Short | 10-32 Flat-Bottom | 400–800 psi (27–55 bar) | 1/4" Hex | PEEK Red | 10-pk |
| P-844x | VacuTight Fitting for 1/16" OD Tubing, Short | 10-32 Flat-Bottom | 400–800 psi (27–55 bar) | Headless Knurl | PEEK Red | 10-pk |
| P-846x | VacuTight Fitting for 1/16" OD Tubing, Long | 10-32 Flat-Bottom | 400–800 psi (27–55 bar) | Headless Knurl | PEEK Red | 10-pk |
| P-930x | VacuTight Fitting for 1/16" OD Tubing | 1/4-28 Flat-Bottom | 400–800 psi (27–55 bar) | Standard Knurl | Delrin Red | 10-pk |
| P-931x | VacuTight Fitting for 1/16" OD Tubing | M6 Flat-Bottom | 400–800 psi (27–55 bar) | Standard Knurl | Delrin Red | 10-pk |
| P-938x | VacuTight Fitting for 1/16" OD Tubing | 1/4-28 Flat-Bottom | 400–800 psi (27–55 bar) | Standard Knurl | PEEK Natural | 10-pk |
| P-942x | VacuTight Fitting for 1/8" OD Tubing | 1/4-28 Flat-Bottom | 500–1,000 psi (34–69 bar) | Standard Knurl | Delrin Red | 10-pk |
| P-945x | VacuTight Fitting for 1/8" OD Tubing, Short | M6 Flat-Bottom | 500–1,000 psi (34–69 bar) | Standard Knurl | Delrin Black | 10-pk |
| P-946x | VacuTight Fitting for 1/8" OD Tubing | 1/4-28 Flat-Bottom | 500–1,000 psi (34–69 bar) | Headless Knurl | Delrin Red | 10-pk |
| P-948x | VacuTight Fitting for 1/8" OD Tubing | 1/4-28 Flat-Bottom | 500–1,000 psi (34–69 bar) | Standard Knurl | PEEK Natural | 10-pk |
| REPLACEMENT FERRULES | | | | | | |
| P-840 | VacuTight Ferrule for 1/16" OD Tubing | M6 or 1/4-28 Flat-Bottom | 400–800 psi (27–55 bar) | — | ETFE Red | ea. |
| P-940x | VacuTight Ferrule for 1/8" OD Tubing | M6 or 1/4-28 Flat-Bottom | 500–1,000 psi (34–69 bar) | — | ETFE Red | 10-pk |

Metric Flangeless Fittings

- › For 1/16", 1.8 mm, 2.0 mm, 2.5 mm, 3.0 mm, 4.0 mm, or 1/8" OD tubing
- › Convenience of flangeless fittings for metric tubing sizes and M6 flat-bottom ports

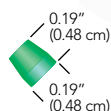

P-342x
ETFE Ferrule
for 1.8 OD tubing

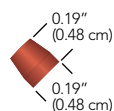

P-363Rx
ETFE Ferrule
for 2.0 mm OD tubing

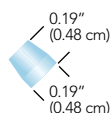

P-353x
ETFE Ferrule
for 2.5 mm OD tubing

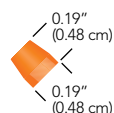

P-343x
ETFE Ferrule
for 3.0 mm OD tubing

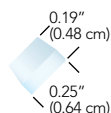

P-344x
ETFE Ferrule
for 4.0 mm OD tubing

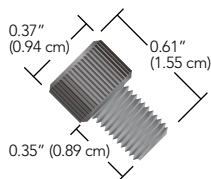

P-347x
PEEK Nut
for 1.8, 2.0, 3.0 mm or
1/8" OD tubing

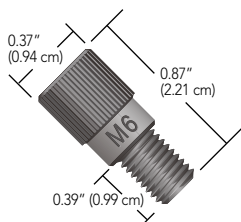

P-207x
Delrin® Nut
for 1/16" OD tubing

Metric Flangeless Ferrules are designed to connect 1.8, 2.0, 2.5, 3.0, or 4.0 mm OD tubing to flat-bottom ports when paired with the appropriate M6, 1/4-28, or 5/16-24 Flangeless Nuts. We also offer M6-threaded nuts to connect 1/16" or 1/8" OD tubing, plus a tubing sleeve to facilitate 1.0 mm OD tubing connections. Please refer to the "Metric Connections" chart on this page for information regarding which nuts and ferrules to use with your tubing.



METRIC CONNECTIONS

Use this chart to determine the low pressure fittings needed to connect metric and English-sized tubing into the indicated ports.

| Tubing Size | Port | Ferrules | Nuts |
|-------------|---------|---------------------------------------|---|
| 1.0 mm | M6 | P-200x (w/F-252 sleeve, not included) | P-207x, P-207Sx, P-247x |
| | 1/4-28 | P-200x (w/F-252 sleeve, not included) | Any 1/4-28 nut for 1/16" OD tubing from page 47 |
| 1.8 mm | M6 | P-342x | P-307x, P-307Sx, P-347x |
| | 1/4-28 | P-342x | Any 1/4-28 nut for 1/8" OD tubing from page 47 |
| 2.0 mm | M6 | P-363Rx | P-307x, P-307Sx, P-347x |
| | 1/4-28 | P-363Rx | Any 1/4-28 nut for 1/8" OD tubing from page 47 |
| 2.5 mm | M6 | P-353x | P-307x, P-307Sx, P-347x |
| | 1/4-28 | P-353x | Any 1/4-28 nut for 1/8" OD tubing from page 47 |
| 3.0 mm | M6 | P-343x | P-307x, P-307Sx, P-347x |
| | 1/4-28 | P-343x | Any 1/4-28 nut for 1/8" OD tubing from page 47 |
| 4.0 mm | 5/16-24 | P-344x | XP-132x from page 58 |
| | M6 | P-200x | |
| 1/16" | M6 | P-840 | P-207x, P-207Sx, P-247x, P-931, page 42 |
| | M6 | P-840 | |
| 1/8" | M6 | P-300x | |
| | M6 | P-940x | P-307x, P-307Sx, P-347x, P-945x, page 42 |



RELATED PRODUCTS

| | Page | Page |
|---|------|--|
| MORE METRIC-SIZED PRODUCTS | | |
| High Pressure Polymer Fittings | 60 | Low Pressure Unions 86 |
| High Pressure Stainless Steel Fittings | 61 | Bulkhead Unions 84 |
| Luer Adapters | 89 | PEEK (1.8 mm OD and Capillary) and Fused Silica Tubing 16 |
| Metric Threaded Adapters | 67 | PEEKsil™ Tubing 22 |
| External NPT Adapters | 68 | FEP Tubing (1.0–4.0 mm OD) and PFA Capillary Tubing 26 |
| VacuTight™ Fittings | 42 | Frit-In-A-Ferrule™ 101 |
| Plugs and Caps | 57 | |

In addition, many of our 1/4-28 threaded Filters, Valves and Flow Control Accessories can be converted to accept 1.8, 2.0, 2.5 and 3.0 mm tubing, using the ferrules listed for 1/4-28 ports in the "Metric Connections" table, this page.

| Part No. | Description | Port | Pressure Rating | Head Style | Material | Qty. |
|-------------------------------|---|--------------------------|---------------------|----------------|--------------|-------|
| METRIC FLANGELESS NUTS | | | | | | |
| P-207x | Flangeless Nut for 1/16" OD Tubing | M6 Flat-Bottom | 2,000 psi (138 bar) | Standard Knurl | Delrin Black | 10-pk |
| P-2075x | Flangeless Nut for 1/16" OD Tubing, Short | M6 Flat-Bottom | 2,000 psi (138 bar) | Standard Knurl | Delrin Black | 10-pk |
| P-247x | Flangeless Nut for 1/16" OD Tubing, Short | M6 Flat-Bottom | 2,000 psi (138 bar) | Standard Knurl | PEEK Black | 10-pk |
| P-307x | Flangeless Nut for 1.8 mm, 2.0 mm, 3.0 mm, 1/8" OD Tubing | M6 Flat-Bottom | 500 psi (34 bar) | Standard Knurl | Delrin Black | 10-pk |
| P-3075x | Flangeless Nut for 1.8 mm, 2.0 mm, 3.0 mm, 1/8" OD Tubing | M6 Flat-Bottom | 500 psi (34 bar) | Standard Knurl | Delrin Black | 10-pk |
| P-347x | Flangeless Nut for 1.8 mm, 2.0 mm, 3.0 mm, 1/8" OD Tubing | M6 Flat-Bottom | 500 psi (34 bar) | Standard Knurl | PEEK Black | 10-pk |
| FLANGELESS FERRULES | | | | | | |
| F-252x | 1/16" OD Tubing Sleeve for 1.0 mm ID Tubing | M6 or 1/4-28 Flat-Bottom | 500 psi (34 bar) | — | FEP Purple | 10-pk |
| P-200x | Flangeless Ferrule for 1/16" OD Tubing | M6 or 1/4-28 Flat-Bottom | 2,000 psi (138 bar) | — | ETFE Blue | 10-pk |
| P-300x | Flangeless Ferrule for 1/8" OD Tubing | M6 or 1/4-28 Flat-Bottom | 500 psi (34 bar) | — | ETFE Yellow | 10-pk |
| P-342x | Flangeless Ferrule for 1.8 mm OD Tubing | M6 or 1/4-28 Flat-Bottom | 500 psi (34 bar) | — | ETFE Green | 10-pk |
| P-343x | Flangeless Ferrule for 3.0 mm OD Tubing | M6 or 1/4-28 Flat-Bottom | 500 psi (34 bar) | — | ETFE Orange | 10-pk |
| P-344x | Flangeless Ferrule for 4.0 mm OD Tubing | 5/16-24 | 250 psi (17 bar) | — | ETFE Natural | 10-pk |
| P-353x | Flangeless Ferrule for 2.5 mm OD Tubing | M6 or 1/4-28 Flat-Bottom | 500 psi (34 bar) | — | ETFE Natural | 10-pk |
| P-363Rx | Flangeless Ferrule for 2.0 mm OD Tubing | M6 or 1/4-28 Flat-Bottom | 500 psi (34 bar) | — | ETFE Red | 10-pk |



Flanged Fittings

- › Fittings for 1/16" or 1/8" OD tubing, supplied with nut and 316 stainless steel washer
- › Multiple head styles and materials available; contact IDEX Health & Science for more information
- › For 1/4-28 and M6 flat-bottom ports
- › Some color options available; call for more information

Flanged Fittings are compatible with most standard 1/4-28 or M6 Flat-Bottom flanged fittings. The Delrin® (acetal resin) nut resists cross threading or loosening during use.

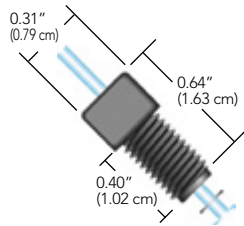

P-401x¹
Flanged Fitting for 1/16" OD tubing*

¹ The dimensions shown apply to all square-head Flanged Fittings

* Flanged tubing not included

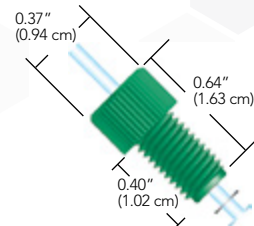

P-482G³
Flanged Fitting for 1/16" OD tubing*

³ The dimensions shown apply to all knurled-head Flanged Fittings

* Flanged tubing not included



RELATED PRODUCTS

- › For an alternative to flanging tubing, we highly recommend the Flangeless Fittings found on page 45, the Super Flangeless™ Fittings found on page 39, or the VacuTight™ Fittings on page 42.

| Part No. | Description | Port Geometry | Head Style | Material (Nut/Washer) | Qty. |
|--|-------------------------------------|--------------------|----------------|-----------------------|-------|
| FLANGED FITTINGS (INCLUDES STAINLESS STEEL WASHERS) | | | | | |
| P-401x | Flanged Fitting for 1/16" OD Tubing | 1/4-28 Flat-Bottom | 5/16" Square | Delrin Black/SST | 10-pk |
| P-482BLK | Flanged Fitting for 1/16" OD Tubing | 1/4-28 Flat-Bottom | Standard Knurl | Delrin Black/SST | ea. |
| P-501x | Flanged Fitting for 1/8" OD Tubing | 1/4-28 Flat-Bottom | 5/16" Square | Delrin Black/SST | 10-pk |
| P-982BLKx | Flanged Fitting for 1/16" OD Tubing | M6 Flat-Bottom | Standard Knurl | Delrin Black/SST | 10-pk |
| P-1082BLKx | Flanged Fitting for 1/8" OD Tubing | M6 Flat-Bottom | Standard Knurl | Delrin Black/SST | 10-pk |
| REPLACEMENT WASHERS | | | | | |
| P-407x | Washer for 1/16" OD Tubing | 1/4-28 Flat-Bottom | — | SST | 10-pk |
| P-507x | Washer for 1/8" OD Tubing | 1/4-28 Flat-Bottom | — | SST | 10-pk |
| P-1087x | Washer for 1/8" OD Tubing | M6 Flat-Bottom | — | SST | 10-pk |



Flangeless Fittings

★ THE CONVENIENCE OF FLANGELESS FITTINGS



Our Flangeless Nuts provide fingertight convenience — no wrenches required.

Our Flangeless Ferrules provide a leak-proof seal. There is no need to spend time flanging tubing.

Flangeless Fittings eliminate the need to flange tubing. This removable and reusable system provides several benefits:

Convenience: Flangeless Fittings are easy to use. Just slip the nut and ferrule over the tubing and finger tighten the assembly into your receiving port. In tests, it is shown that the ideal amount of torque to achieve expected part performance should be approximately 3–4 in-lbs (0.34–0.45 N·m). Check out the line of special tightening tools designed to adapt to many standard torque wrenches, on page 52 and the adjustable torque driver, VHP-4000 on page 53.

Minimal Down-Time: Component replacement is quick, taking only a few seconds — unlike the significant time required to flange tubing.

Cost-Effectiveness: Repairing a flanged tubing assembly requires a costly flanging tool or the purchase of a complete replacement assembly, including a new length of tubing and a set of fittings. The Flangeless Fittings system typically requires only one new ferrule at minimal cost when repairing a connection.

The 1/4-28 and M6 Flangeless Fittings for 1/16", 1/8", and metric sized OD tubing are summarized on the following page and listed on page 47.

1/4-28 Flangeless Fittings – Nuts

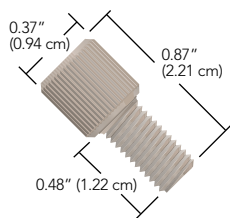

Standard

XP-201x
XP-202x
XP-220x
XP-230x
XP-238x
XP-245x
XP-301x – XP-305x
XP-330x

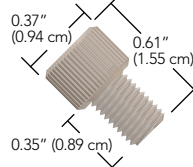

Short

XP-218x
XP-235x
XP-308x
XP-335x
P-207Sx
P-247x
P-307Sx
P-347x

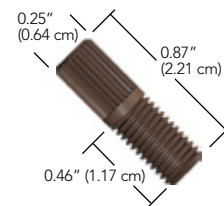

Headless

XP-286x

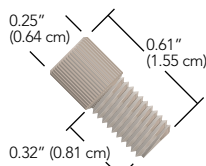

Short Headless

XP-283x

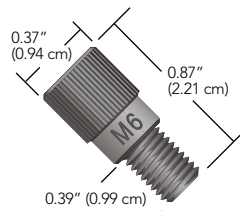

Standard Metric

P-207x
P-307x

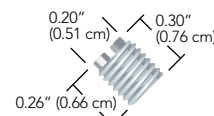

FlushNut™

XF-358x
XF-368x

Flangeless Fittings (Cont.)

NOTE

- › The XP-340x ferrule is designed for use with shallow receiving ports, such as those used on some low pressure valves.



XP-340x
ETFE Small Valve Ferrule

- › The XF-368x FlushNut is an excellent choice for applications where port-to-port spacing is limited; see page 31 for more information on this innovative product line. As an alternative, consider one of the "headless" fittings shown on this page.

Ferrules

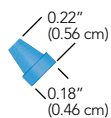

Standard 1/16"
P-200x
XP-200Nx

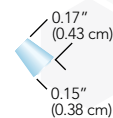

Small Valve 1/16"
XP-240x

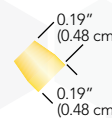

**Standard 1/8"
and Metric Ferrules**
XP-300x
XP-300Nx
P-342x
P-353x
P-363Rx
P-343x

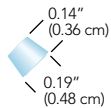

Small Valve 1/8"
XP-340x

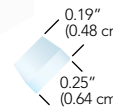

Standard 4.0 mm
P-344x

RELATED PRODUCTS

- › For the Large Bore Flangeless Fittings, please refer to page 58.
- › Nuts for M6 threaded ports are on page 43; nuts for 5/16-24 threaded ports are on page 58.

Flangeless Fittings for 1/16" and 1/8" OD Tubing

- › Wide variety of materials and geometries to fit most applications
- › Excellent replacement for flanged fittings
- › Convenient and easy to use
- › Fittings and ferrules packaged together for easy ordering convenience

Flangeless Fittings for 1/16" OD Tubing, and for 1/8" OD Tubing are available in a variety of materials. The replacement ferrules are manufactured from inert ETFE, and are sold in a colored version or ETFE's natural color as the N option. The smaller ferrules, XP-240x and XP-340x are designed for shallow ports.

The fittings shown on this page are packaged together with the ferrules in convenient 10-packs. The 1/16" version include the XP-200x ferrule, and the 1/8" version include the XP-300x ferrule. Please visit our website, www.idex-hs.com, for single packaging options.

For higher pressure and temperature applications consider our Super Flangeless™ found on page 39.

Lock Nut

The XP-312x Lock Nut is for use with any 1/4-28 male Flangeless Fitting. Use this product in applications where vibrations can loosen fittings.

To Use: Thread the lock nut onto the male fitting. When the male fitting is firmly seated into the receiving port, tighten the lock nut down against the receiving port to securely hold the male fitting in place.



XP-312x
Lock Nut White Delrin

Flangeless Fittings

| Part No. | Description | Port | Pressure Rating | Head Style | Material | Qty. |
|---|---|-----------------------------|---------------------|----------------|---------------|-------|
| FLANGELESS FITTINGS FOR 1/16" OD TUBING | | | | | | |
| XF-358x | Flangeless Fitting for 1/16" OD Tubing, FlushNut | 1/4-28 Flat-Bottom | 2,000 psi (138 bar) | FlushNut | SST | 10-pk |
| XLT-111x | Flangeless Fitting for 1/16" OD Tubing | 10-32 Flat-Bottom | 2,500 psi (172 bar) | Standard Knurl | PEEK Natural | 10-pk |
| XP-201x | Flangeless Fitting for 1/16" OD Tubing | 1/4-28 Flat-Bottom | 2,000 psi (138 bar) | Standard Knurl | Delrin Black | 10-pk |
| XP-202x | Flangeless Fitting for 1/16" OD Tubing | 1/4-28 Flat-Bottom | 2,000 psi (138 bar) | Standard Knurl | Delrin Red | 10-pk |
| XP-218x | Flangeless Fitting for 1/16" OD Tubing | 1/4-28 Flat-Bottom | 2,000 psi (138 bar) | Standard Knurl | ETFE Natural | 10-pk |
| XP-230x | Flangeless Fitting for 1/16" OD Tubing | 1/4-28 Flat-Bottom | 2,000 psi (138 bar) | Standard Knurl | PEEK Natural | 10-pk |
| XP-235x | Flangeless Fitting for 1/16" OD Tubing, Short | 1/4-28 Flat-Bottom | 2,000 psi (138 bar) | Standard Knurl | PEEK Natural | 10-pk |
| XP-238x | Flangeless Fitting for 1/16" OD Tubing | 1/4-28 Flat-Bottom | 2,000 psi (138 bar) | Standard Knurl | Delrin Purple | 10-pk |
| XP-245x | Flangeless Fitting for 1/16" OD Tubing | 1/4-28 Flat-Bottom | 2,000 psi (138 bar) | Standard Knurl | PFA Natural | 10-pk |
| XP-286x | Flangeless Fitting for 1/16" OD Tubing | 1/4-28 Flat-Bottom | 2,000 psi (138 bar) | Headless Knurl | PPS Natural | 10-pk |
| REPLACEMENT FERRULES FOR 1/16" OD TUBING | | | | | | |
| XP-200x | Flangeless Ferrule for 1/16" OD Tubing | 1/4-28 Flat-Bottom | 2,000 psi (138 bar) | — | ETFE Blue | 10-pk |
| XP-200Nx | Flangeless Ferrule for 1/16" OD Tubing | 1/4-28 Flat-Bottom | 2,000 psi (138 bar) | — | ETFE Natural | 10-pk |
| XP-240x | Flangeless Ferrule for 1/16" OD Tubing, Small Valve | 1/4-28 or 10-32 Flat-Bottom | 2,500 psi (172 bar) | — | ETFE Natural | 10-pk |
| FLANGELESS FITTINGS FOR 1/8" OD TUBING (INCLUDES P-300 FERRULES) | | | | | | |
| XF-368x | Flangeless Fitting for 1/8" OD Tubing, FlushNut | 1/4-28 Flat-Bottom | 500 psi (34 bar) | FlushNut | SST | 10-pk |
| XP-301x | Flangeless Fitting for 1/8" OD Tubing | 1/4-28 Flat-Bottom | 500 psi (34 bar) | Standard Knurl | Delrin Black | 10-pk |
| XP-302x | Flangeless Fitting for 1/8" OD Tubing | 1/4-28 Flat-Bottom | 500 psi (34 bar) | Standard Knurl | Delrin Red | 10-pk |
| XP-305x | Flangeless Fitting for 1/8" OD Tubing | 1/4-28 Flat-Bottom | 500 psi (34 bar) | Standard Knurl | Delrin Green | 10-pk |
| XP-308x | Flangeless Fitting for 1/8" OD Tubing, Short | 1/4-28 Flat-Bottom | 500 psi (34 bar) | Standard Knurl | Delrin Black | 10-pk |
| XP-315x | Flangeless Fitting for 1/8" OD Tubing | 1/4-28 Flat-Bottom | 500 psi (34 bar) | Standard Knurl | ETFE Natural | 10-pk |
| XP-330x | Flangeless Fitting for 1/8" OD Tubing | 1/4-28 Flat-Bottom | 500 psi (34 bar) | Standard Knurl | PEEK Natural | 10-pk |
| XP-335x | Flangeless Fitting for 1/8" OD Tubing, Short | 1/4-28 Flat-Bottom | 500 psi (34 bar) | Standard Knurl | PEEK Natural | 10-pk |
| REPLACEMENT FERRULES FOR 1/8" OD TUBING | | | | | | |
| XP-300x | Flangeless Ferrule for 1/8" OD Tubing | 1/4-28 Flat-Bottom | 500 psi (34 bar) | — | ETFE Yellow | 10-pk |
| XP-300Nx | Flangeless Ferrule for 1/8" OD Tubing | 1/4-28 Flat-Bottom | 500 psi (34 bar) | — | ETFE Natural | 10-pk |
| XP-340x | Flangeless Ferrule for 1/8" OD Tubing, Small Valve | 1/4-28 Flat-Bottom | 500 psi (34 bar) | — | ETFE Natural | 10-pk |
| XP-312x | Lock Nut for Flangeless Nuts | 1/4-28 Flat-Bottom | — | — | Delrin White | 10-pk |



Bio

- › Finger-tight to 19,000 psi (1,310 bar / 130 MPa)
- › 100+ Connect and Disconnects
- › No Peak Tailing or Broadening
- › Clicks for Exact Tightening
- › Minimize Carryover Risk



LEARN MORE

Learn more about MarvelXACT Fitting System at www.idex-hs.com/MarvelXACT



NOTE

- › MarvelXACT tubing includes a sleeve to assist in product identification, containing details for ID, length, and part number:



- › Minimum recommended bend-radius with MarvelXACT tubing is 1/4" (~6.35 mm).



REGULATORY COMPLIANCE

- › As of the date of publication, MarvelXACT is compliant with current RoHS and REACH regulations.

UHPLC Connection Systems

MarvelXACT™ Fitting System

Our expertly designed MarvelXACT connection system takes the guesswork out of your process by eliminating the risk of under- and over-tightening, with our patented torque-limiting mechanism. This unique feature provides a haptic "click" feedback when it reaches the optimum torque, assuring a perfect connection every time. Built with sturdy, bioinert PEEK and stainless steel, MarvelXACT can be connected and disconnected more than 100 times. MarvelXACT also incorporates our advanced MarvelX Sealing Technology to deliver precise face sealing (sealing at the port bottom), which eliminates additional internal volume, and minimizes carryover risk, peak tailing, and peak broadening. The MarvelXACT connection system incorporates flexible 1/32" OD tubing to easily route through your system, is compatible with 10-32 coned receiving ports, and is absolutely finger-tight — no tool required. Additionally, MarvelXACT utilizes our exclusive next-generation patented technology to auto-adjust to various port depths.

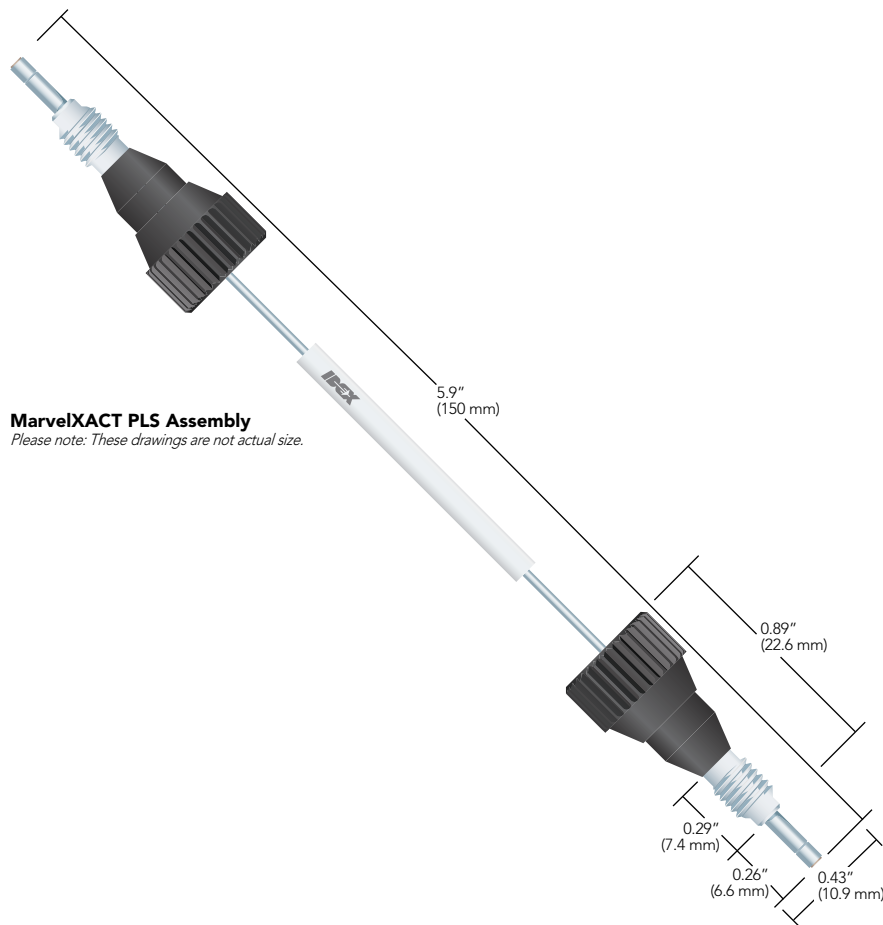



SPECIFICATIONS & DETAILS

| | |
|----------------------------|--|
| Pressure Capability | 19,000 psi (~1,310 bar, 131 MPa) for routine use |
| Installation Method | Finger-tighten until the first "click" feedback is received |
| Tubing Type | 1/32" OD flexible 316 Stainless Steel with 1/16" OD rigid tube ends |
| Fitting Type | 10-32 threaded, PEEK fittings with 316 Stainless Steel threads |
| Wetted Materials | PEEK-Lined versions: PEEK Stainless Steel versions: PEEK and 316 Stainless Steel |
| Max Use Temperature | 120 °C |

NOTE: The above performance specifications apply to use with appropriately-designed receiving ports under optimal conditions, using water for the testing process. If different conditions are used, the expected pressure threshold will be different.



MARVELXACT VS. CONVENTIONAL CONED FITTINGS

Conventional coned fittings require a ferrule in conjunction with a fitting for proper sealing. They depend on complex techniques, including tools, to improve sealing performance, which significantly increases probability of extra internal volume and poor chromatography results. The excessive force needed for tightening increases wear of expensive components and the likelihood of replacement, adding to overall costs.

MarvelXACT fittings do not depend on ferrules. They seal at the bottom of the port, without complex techniques, which significantly reduces required torque and enables many more connects and disconnects. MarvelXACT significantly reduces wear on your hardware, increasing product life. An enhanced proprietary tip design also ensures zero dead volume (ZDV) and better chromatography results.

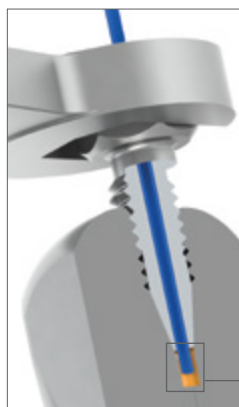

EXTRA
INTERNAL
VOLUME

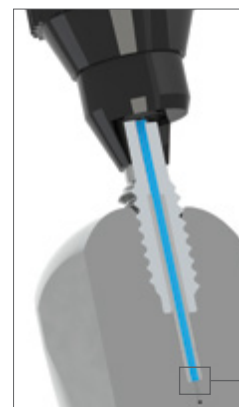

ZERO
DEAD
VOLUME

MarvelXACT

| Length | 150 MM Part No. | 250 MM Part No. | 350 MM Part No. | 500 MM Part No. | 600 MM Part No. |
|---|--------------------|--------------------|--------------------|--------------------|--------------------|
| PEEK-LINED STAINLESS STEEL ASSEMBLIES* | | | | | |
| 25 µm ID | UPFP-7025150 | UPFP-7025250 | UPFP-7025350 | UPFP-7025500 | UPFP-7025600 |
| 50 µm ID | UPFP-7050150 | UPFP-7050250 | UPFP-7050350 | UPFP-7050500 | UPFP-7050600 |
| 75 µm ID | UPFP-7075150 | UPFP-7075250 | UPFP-7075350 | UPFP-7075500 | UPFP-7075600 |
| 100 µm ID | UPFP-7100150 | UPFP-7100250 | UPFP-7100350 | UPFP-7100500 | UPFP-7100600 |
| STAINLESS STEEL ASSEMBLIES* | | | | | |
| 100 µm ID | UPFS-7100150 | UPFS-7100250 | UPFS-7100350 | UPFS-7100500 | UPFS-7100600 |
| 125 µm ID | UPFS-7125150 | UPFS-7125250 | UPFS-7125350 | UPFS-7125500 | UPFS-7125600 |
| 254 µm ID | UPFS-7254150 | UPFS-7254250 | UPFS-7254350 | UPFS-7254500 | UPFS-7254600 |

*Product availability and lead times may vary depending on the configuration. Contact Customer Service at +1 800 426 0191 or email CustomerService.hs@idexcorp.com for details.

INSTRUCTIONS FOR TIGHTENING

- 1 Route tubing to the target port.
- 2 Slide fitting onto the tubing end via slot.
- 3 Slowly finger-tighten to first resistance; continue tightening 1/8-turn (45° angle).



MARVELX UHPLC FITTINGS VS. CONVENTIONAL CONED FITTINGS

Conventional coned fittings require a ferrule in conjunction with a fitting for proper sealing. They depend on complex techniques, including tools, to improve sealing performance, which significantly increases probability of extra internal volume and poor chromatography results. The excessive force needed for tightening increases wear of expensive components and the likelihood of replacement, adding to overall costs.

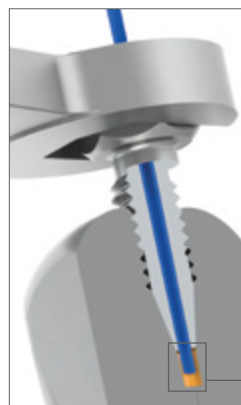

MarvelX UHPLC fittings do not depend on ferrules. They seal at the bottom of the port, without complex techniques, which significantly reduces required torque and enables many more connects and disconnects. Furthermore, they are virtually impossible to over-tighten by hand, limiting wear and increasing product life. An enhanced proprietary tip design also ensures zero dead volume (ZDV) and better chromatography results.

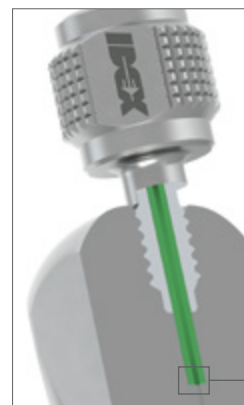

MarvelX

| Length | 070 MM Part No. | 150 MM Part No. | 250 MM Part No. | 350 MM Part No. | 500 MM Part No. | 600 MM Part No. |
|---|--------------------|--------------------|--------------------|--------------------|--------------------|--------------------|
| PEEK-LINED STAINLESS STEEL ASSEMBLIES* | | | | | | |
| 25 µm ID | UPFP-6025070 | UPFP-6025150 | UPFP-6025250 | UPFP-6025350 | UPFP-6025500 | UPFP-6025600 |
| 50 µm ID | UPFP-6050070 | UPFP-6050150 | UPFP-6050250 | UPFP-6050350 | UPFP-6050500 | UPFP-6050600 |
| 75 µm ID | UPFP-6075070 | UPFP-6075150 | UPFP-6075250 | UPFP-6075350 | UPFP-6075500 | UPFP-6075600 |
| 100 µm ID | UPFP-6100070 | UPFP-6100150 | UPFP-6100250 | UPFP-6100350 | UPFP-6100500 | UPFP-6100600 |
| STAINLESS STEEL ASSEMBLIES* | | | | | | |
| 100 µm ID | UPFS-6100070 | UPFS-6100150 | UPFS-6100250 | UPFS-6100350 | UPFS-6100500 | UPFS-6100600 |
| 125 µm ID | UPFS-6125070 | UPFS-6125150 | UPFS-6125250 | UPFS-6125350 | UPFS-6125500 | UPFS-6125600 |
| 254 µm ID | UPFS-6254070 | UPFS-6254150 | UPFS-6254250 | UPFS-6254350 | UPFS-6254500 | UPFS-6254600 |
| REPLACEMENT PARTS* | | | | | | |

Replacement Tubing To order Replacement Tubing, simply add the letter "T" to the end of any of the part numbers listed above.
Example: UPFP-6025070T is the replacement tubing for UPFP-6025070.

Replacement Fittings UPN-61032 – Includes 3 replacement fittings.

*Product availability and lead times may vary depending on the configuration. Contact Customer Service at +1 800 426 0191 or email CustomerService.hs@idexcorp.com for details.



Fittings Tools



VHP-1000
VHP Wrench
1/4 in Hex 10 in-lbs (1.13 N·m)

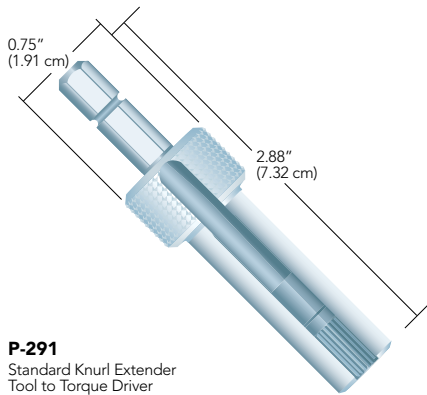

P-291
Standard Knurl Extender
Tool to Torque Driver

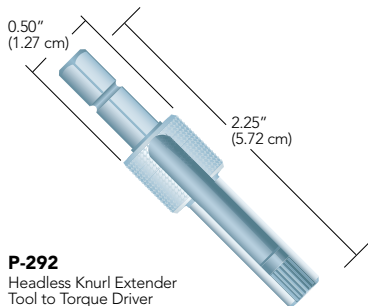

P-292
Headless Knurl Extender
Tool to Torque Driver

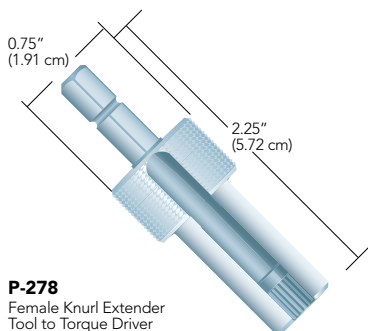

P-278
Female Knurl Extender
Tool to Torque Driver

Tightening Tools for VHP & Other Fittings

- › Configured for the optimum torque to provide assurance of a strong connection
- › Prolongs the lifetime of reusable fittings by not overtightening
- › Available for multiple fitting head styles

This new line of tightening tools is designed for the VHP fittings and can also be used with any fitting in this chapter described to have a corresponding head style to the tool listed below. There are three styles of tightening tools available for various applications. The Torque Tools (VHP-1000 and VHP-2000) are breakaway torque wrenches designed to deliver a precise amount of torque to the fitting system. These torque wrenches come calibrated according to ISO 6789:2003 ($\pm 6\%$ of setting) and have been tested extensively with the reusable VHP fittings on page 62. Choose the appropriate torque delivered and the proper head style to work with the VHP fittings, increasing the ease of use with these fittings.

The VHP-4000 Torque Driver couples with the specially designed Extender Tools listed below and provides an externally adjustable torque setting. This tool along with the appropriate Extender Tools will tighten any IDEX Health & Science knurled polymer fitting in your system. Reference the head style found in the tables at the bottom of each page for information on the proper Extender Tool to select.

Because of the small hex-head on the M4 fittings (VHP-900 and VHP-920), a custom wrench, the VHP-9000, is available in the table at the bottom of the page 53.

Extender Tools

These tools can be used to tighten most of our knurled nuts in hard to reach places. See the application note on this page for knurl size and corresponding extender tool.

For precise tightening, the extender tools listed with 1/4" hex drives are designed to adapt to any torque wrench with a female 1/4" socket, such as the VHP-4000 Torque Driver on page 53. The tools featured on this page also include the FlushNut™ wrenches, used to tighten the FlushNuts found throughout this chapter and described in detail on page 53.

APPLICATION NOTE

The drawings represent actual size of the various knurled head designs of the IDEX Health & Science nuts featured in this chapter. Select the appropriate extender tool for the knurl pattern of the nut you've selected.

| FEMALE KNURL | STANDARD KNURL | HEADLESS KNURL |
|----------------------|----------------------|----------------|
| | | |
| STANDARD MICRO KNURL | MICRO HEADLESS KNURL | |
| | | |



Removal Tool

Use the LT-300 Removal Tool to detach LiteTouch® and Super Flangeless™ Ferrules from tubing. Simply slide the appropriate tool blade slot between the lock ring and the ferrule body. With a slight twist, the ring will pop off, releasing the ferrule from the tubing. *Please Note: This Removal Tool will not work with the LT-135x Ferrule System.*



Wrenches

For your convenience, we offer wrenches in three standard sizes. You will need two A-304 wrenches to tighten most nuts into unions found on page 36 (for union 1593, you need one A-304 and one A-320 wrench).

The IDEX Wrench is slotted to fit over 1/16" and 1/8" OD tubing, and has 1/4" and 5/16" internal hex ends, to engage with the heads of the hex-head fittings most commonly used with IDEX Health & Science valves and the stainless steel fittings listed on page 61.

Fittings Tools

| Part No. | Description | Use With Head Style | Torque Delivered | Qty. |
|-----------------------------|---|--------------------------|--|------|
| VHP TIGHTENING TOOLS | | | | |
| F-347 | Extender Tool to Torque Driver | FlushNut (1/4-28) | — | ea. |
| N-291 | Extender Tool to Torque Driver | Micro Headless | — | ea. |
| P-268 | Extender Tool to Torque Driver | 1/4" Hex | — | ea. |
| P-278 | Extender Tool to Torque Driver | Female Nut Knurl | — | ea. |
| P-279 | Extender Tool to Torque Driver | Micro Nut Knurl | — | ea. |
| P-291 | Extender Tool to Torque Driver | Standard Nut Knurl | — | ea. |
| P-292 | Extender Tool to Torque Driver | Headless Nut Knurl | — | ea. |
| P-1000 | Standard Knurl Torque Tool | Standard Knurl | 4 in-lbs (0.45 N-m) | ea. |
| VHP-1000 | VHP Torque Tool | 1/4" Hex | 10 in-lbs (1.13 N-m) | ea. |
| VHP-2000 | VHP Torque Tool | 1/4" Hex | 14 in-lbs (1.58 N-m) | ea. |
| VHP-4000 | VHP Torque Driver | Extender Tool 1/4" Drive | Adjustable between 2–12 in-lbs (0.23–1.35 N-m) | ea. |
| VHP-9000 | 4 mm Wrench | 4 mm Hex | — | ea. |
| EXTENDER TOOLS | | | | |
| Part No. | Description | Material | | Qty. |
| P-291 | Extender Tool for Standard Head Nuts, with 1/4" Hex Drive | Aluminum | | ea. |
| P-298 | Extender Tool for Standard Head Nuts | Delrin® | | ea. |
| P-299 | Extender Tool for Standard Head Nuts | Aluminum | | ea. |
| P-399 | Extender Tool for Standard Head Nuts, Short | Aluminum | | ea. |
| P-297 | Extender Tool for Headless Nuts | Aluminum | | ea. |
| P-292 | Extender Tool for Headless Nuts, with 1/4" Hex Drive | Aluminum | | ea. |
| P-277 | Extender Tool for Standard Micro Nuts | Aluminum | | ea. |
| N-290 | Extender Tool for Micro Headless Nuts | Aluminum | | ea. |
| P-278 | Extender Tool for Female Nuts, with 1/4" Hex Drive | Aluminum | | ea. |
| MISCELLANEOUS TOOLS | | | | |
| A-304 | Wrench, 1/4" x 5/16" | Steel | | ea. |
| A-305 | Wrench, 1/2" x 9/16" | Steel | | ea. |
| A-320 | Wrench, 3/8" x 7/16" | Steel | | ea. |
| 6810 | IDEX Wrench, 1/4" x 5/16" | Steel | | ea. |
| F-345 | FlushNut Wrench for 10-32 Threaded Fittings | Steel/Plastic Handle | | ea. |
| F-346 | FlushNut Wrench for 1/4-28 Threaded Fittings | Steel/Plastic Handle | | ea. |
| LT-300 | Removal Tool for LiteTouch and Super Flangeless Ferrules | Steel/Plastic Handle | | ea. |
| M-150 | Swaging Tool for TinyTight Fittings, for 6–40 Port | SST | | ea. |



Tubing Sleeves

MicroTight® Tubing Sleeves

- › Manufactured from PEEK polymer
- › Pressure rated to 4,000 psi (276 bar)
- › Color-coded for easy inner diameter identification

IDEX Health & Science MicroTight Tubing Sleeves feature an outer diameter of 0.025" and offer a wide assortment of inner diameters to help facilitate capillary tubing connections with our MicroTight accessories. Because the sleeves are manufactured from PEEK polymer, they carry an upper temperature threshold of 125 °C.

To use these sleeves properly, choose a sleeve with an inner diameter 0.001"–0.002" (25–50 µm) larger than the outer diameter of your capillary tubing. Then, slip the sleeve over your flow path tubing, such that your tubing extends all the way through the sleeve, but not beyond the end of the sleeve. Choose the correct fitting that corresponds with your receiving port, slide it over the sleeved flow path tubing and connect as normal.



NanoTight™ Tubing Sleeves

- › Manufactured from FEP fluoropolymer
- › Pressure rated to 4,000 psi (276 bar)
- › Outer diameter of 1/16" — the most popular size used on most instrumentation

NanoTight Tubing Sleeves are manufactured using FEP fluoropolymer and precisely cut to a 1.6" length. A wide assortment of sleeves is available, ensuring the availability of a NanoTight sleeve for most applications. Many of the sleeves feature a light color tint that can help more easily identify the inner diameter for future orders. Because FEP is the base polymer for these sleeves, there is a maximum recommended continuous operating temperature of 50 °C.

Our NanoTight sleeves were designed primarily for use with the NanoTight fittings, found on page 37 and also work well with the Super Flangeless™ fittings for 1/16" OD tubing on page 39. For tubing sleeves that can be used effectively with stainless steel fittings and at higher temperatures, consider using the PEEK Tubing Sleeves, found below.



1/16" OD PEEK Tubing Sleeves

- › For connecting capillary tubing to standard 10-32 ports
- › Require the use of wrench tightened stainless steel nuts
- › Pressure rated to 6,000 psi (414 bar)

Like the NanoTight™ FEP Sleeves on the previous page, these PEEK Tubing Sleeves are designed to be used with 1/16" OD, 10-32 threaded fittings to adapt capillary tubing to standard coned ports. Made of PEEK polymer, these 1.3" long sleeves can be used up to 125 °C.

These sleeves require a wrench tightened nut to achieve proper sealing. We recommend our SealTight™ fittings on page 36. Many researchers also use a stainless steel nut and ferrule with these sleeves, such as our U-400 and U-401 (page 33).

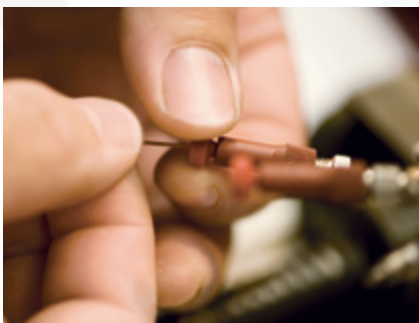

1/32" OD PEEK Tubing Sleeves

These 1.6" long 1/32" OD PEEK Tubing Sleeves can be used with any fitting designed for 1/32" OD tubing when smaller tubing must be connected. Select the appropriate sleeve from the product listing for your capillary tubing OD size. The 1/32" OD PEEK Tubing Sleeves have a maximum recommended temperature of 125 °C and have a pressure rating of 5,000 psi (345 bar).



1/32" OD FEP Tubing Sleeves

These 1.6" long sleeves facilitate connecting capillary tubing into ports designed for 1/32" OD tubing. Please refer to the product listing below to select the appropriate sleeve for your capillary OD size. These sleeves can be used at up to 50 °C and have a pressure rating of 1,750 psi (121 bar).

Clockwise, starting at top:

- › 1/16" OD PEEK Tubing Sleeves, use with U-400 and U-401 (not shown)
- › 1/32" OD FEP Tubing Sleeves, shown with F-126Sx Fitting
- › Fittings and tubing only shown to highlight how sleeves are designed to be used; they are not included with the sleeves



APPLICATION NOTE

Why use Sleeves?

Because most capillary tubing connections are made into coned receiving ports, where the port is not designed to be used with capillary tubing directly, special care must be used to ensure a good connection. While custom ferrules can help make these connections, they only offer a fixed-length nose — and because most tubing pockets will vary slightly in length, this can lead to leaking or dead volume.

To help save overall expense while maintaining a concentric connection with minimal dead volume, IDEX Health & Science recommends the use of sleeves. Because sleeves are not permanently attached to a ferrule, they can easily adapt to varying tubing pocket depths. Additionally, because they are manufactured using extruded polymer tubing, you are assured of the concentricity of the resultant connection.

Tubing Sleeves (Cont.)



RELATED PRODUCTS

Use 1/32" OD PEEK or FEP Sleeves to connect capillary tubing with the following:

- › The F-113 Ferrule and Two-Piece Fingertight Fittings for 10-32 ports (page 35).
- › The F-112 and P-416BLK MicroTight® Fittings (page 34) — 1/32" OD PEEK Tubing Sleeves only.
- › The 1/32" OD MicroTight Fittings on page 34.
- › The RheFlex M4 Fitting (page 63) for MX Module applications; the M-645 Valco®-Compatible Fitting (page 33) for Valco Nanovolume® valve applications.

Tubing Sleeves

| Part No. | ID | For Tubing OD Size | Color | Qty. |
|---|--|--------------------|---------|------|
| MICROTIGHT PEEK TUBING SLEEVES AND KITS, 0.025" OD | | | | |
| F-180 | 125 µm (0.005") | 70–110 µm | Red | ea. |
| F-181 | 180 µm (0.007") | 125–165 µm | Yellow | ea. |
| F-182 | 230 µm (0.009") | 175–215 µm | Natural | ea. |
| F-183 | 280 µm (0.011") | 225–265 µm | Blue | ea. |
| F-184 | 330 µm (0.013") | 275–315 µm | Orange | ea. |
| F-185 | 395 µm (0.0155") | 340–380 µm | Green | ea. |
| F-186 | 455 µm (0.018") | 400–440 µm | Black | ea. |
| F-187 | 535 µm (0.021") | 480–520 µm | Natural | ea. |
| F-188 | 152 µm (0.006") | 95–135 µm | Purple | ea. |
| 1328 | MicroTight Tubing Sleeve Kit, contains (6) each of the sleeve sizes listed above | — | — | ea. |
| 1356 | MicroTight Connector Kit, contains: a 10-pack of each MicroTight Tubing Sleeve (F-180–F-187); (2) P-770 MicroTight Adapters; and (2) MicroTight P-720 Unions | — | — | ea. |
| NANOTIGHT FEP TUBING SLEEVES, 1/16" OD | | | | |
| F-237 | 125 µm (0.005") | 70–110 µm | Red | ea. |
| F-238 | 180 µm (0.007") | 125–165 µm | Yellow | ea. |
| F-239 | 215 µm (0.0085") | 160–200 µm | Natural | ea. |
| F-240 | 280 µm (0.011") | 225–265 µm | Blue | ea. |
| F-241 | 330 µm (0.013") | 275–315 µm | Orange | ea. |
| F-242 | 395 µm (0.0155") | 340–380 µm | Green | ea. |
| F-243 | 455 µm (0.018") | 400–440 µm | Black | ea. |
| F-244 | 535 µm (0.021") | 480–520 µm | Natural | ea. |
| F-245 | 610 µm (0.024") | 555–595 µm | Red | ea. |
| F-246 | 685 µm (0.027") | 630–670 µm | Yellow | ea. |
| F-247 | 840 µm (0.033") | 785–825 µm | Green | ea. |
| F-252 | 1.07 mm (0.042") | 1 mm | Purple | ea. |
| PEEK TUBING SLEEVES FOR 1/16" OD FITTINGS | | | | |
| F-225 | 125 µm (0.005") | 70–110 µm | Red | ea. |
| F-226 | 180 µm (0.007") | 125–165 µm | Yellow | ea. |
| F-227 | 230 µm (0.009") | 175–215 µm | Yellow | ea. |
| F-228 | 250 µm (0.011") | 225–265 µm | Blue | ea. |
| F-229 | 330 µm (0.013") | 275–315 µm | Natural | ea. |
| F-230 | 405 µm (0.016") | 350–390 µm | Orange | ea. |
| F-231 | 560 µm (0.022") | 505–545 µm | Natural | ea. |
| F-232 | 785 µm (0.031") | 730–770 µm | Natural | ea. |
| F-233 | 865 µm (0.034") | 785–825 µm | Blue | ea. |
| F-234 | 685 µm (0.027") | 630–670 µm | Yellow | ea. |
| PEEK TUBING SLEEVES FOR 1/32" OD FITTINGS | | | | |
| F-381 | 180 µm (0.007") | 125–165 µm | Yellow | ea. |
| F-382 | 205 µm (0.008") | 150–190 µm | Natural | ea. |
| F-384 | 255 µm (0.010") | 200–240 µm | Blue | ea. |
| F-385 | 380 µm (0.015") | 325–365 µm | Natural | ea. |
| F-386 | 510 µm (0.020") | 455–495 µm | Orange | ea. |
| F-387 | 250 µm (0.011") | 225–265 µm | Red | ea. |
| F-388 | 330 µm (0.013") | 275–315 µm | Black | ea. |
| FEP TUBING SLEEVES FOR 1/32" OD FITTINGS | | | | |
| F-374 | 280 µm (0.011") | 225–265 µm | Blue | ea. |
| F-375 | 330 µm (0.013") | 275–315 µm | Orange | ea. |
| F-376 | 395 µm (0.0155") | 340–380 µm | Green | ea. |



Plugs & Caps

› Seal 6-32, 6-40, 10-32, 1/4-28, M6, or 5/16-24 threaded ports or fittings

Use our plugs to close off unused ports in valves and multi-port connectors. Our color-coded 10-32 threaded plugs are perfect for identifying stored columns that have different packing materials, or in which different mobile phases have been utilized. Cap off tubing with one of the PEEK or ETFE caps presented on this page and the appropriate fittings from this chapter.

To help determine which plug or cap is best suited for your application, please visit www.idex-hs.com for detailed chemical compatibility data.

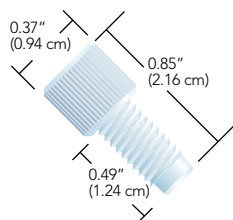

P-316
PFA Plug
for 1/4-28 flat-bottom ports

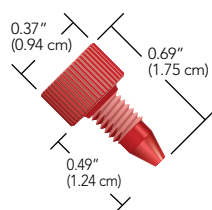

U-467R
Delrin® Column Plug
for 10-32 coned ports

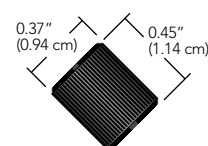

P-755
ETFE Cap
for 1/4-28 flat-bottom fittings

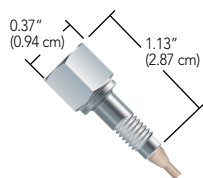

VHP-600
VHP Plug
for 10-32 coned ports

| Part No. | Description | Head Style | Material | Qty. |
|----------------|--|----------------------|---------------|------|
| PLUGS | | | | |
| P-120 | Plug for 1/4-28 Coned Ports for 1/8" OD Tubing | Standard Knurl | PCTFE Natural | ea. |
| P-123 | Plug for 1/4-28 Flat-Bottom Ports | 5/16" Hex | ETFE Natural | ea. |
| P-309 | Plug for 1/4-28 Flat-Bottom Ports | Standard Knurl | Delrin Black | ea. |
| P-311 | Plug for 1/4-28 Flat-Bottom Ports | Standard Knurl | ETFE Natural | ea. |
| P-314 | Plug for M6 Flat-Bottom Ports | Standard Knurl | ETFE Black | ea. |
| P-316 | Plug for 1/4-28 Flat-Bottom Ports | Standard Knurl | PFA Natural | ea. |
| P-321 | Plug for 1/4-28 Flat-Bottom Ports, FlushNut™ | FlushNut | PEEK Natural | ea. |
| P-520 | Plug for 10-32 Coned Ports | 5/16" Hex | SST | ea. |
| P-550 | Plug for 10-32 Coned Ports, Extra Long | Standard Knurl | PEEK Natural | ea. |
| P-551 | Plug for 10-32 Coned Ports | Standard Knurl | PEEK Natural | ea. |
| P-555 | Plug for 6-32 Coned Ports | Standard Micro Knurl | PEEK Natural | ea. |
| P-556 | Plug for 5/16-24 Flat-Bottom Ports | Standard Knurl | PEEK Natural | ea. |
| P-558 | Plug for 6-40 Flat-Bottom Ports | Micro Headless Knurl | PEEK Green | ea. |
| P-849 | Plug for 10-32 Flat-Bottom Ports | Standard Knurl | Delrin Black | ea. |
| U-467R | Plug for 10-32 Coned Ports | Standard Knurl | Delrin Red | ea. |
| VHP-600 | VHP Plug for 10-32 Coned Ports | 3/8" Hex | PK-SST | ea. |
| CAPS | | | | |
| P-754 | Cap for 10-32 Coned Ports | Standard Knurl | ETFE Yellow | ea. |
| P-755 | Cap for 1/4-28 Flat-Bottom Ports | Standard Knurl | ETFE Black | ea. |
| P-756 | Cap for M6 Flat-Bottom Ports | Standard Knurl | ETFE Blue | ea. |

Large Bore Fittings

- › 5/16-24 or 1/2-20 threads
- › For use with 1/16", 1/8", 3/16", 1/4", 5/16", 3.0 mm, or 4.0 mm OD tubing

NOTE

Each of the Large Bore Fittings shown on this page comes in a convenient 10-pack and is packaged with the most popularly chosen Ferrule option. The Fittings can be ordered separately by removing the preceding letter "X" from the part number. Additionally, to connect metric-sized tubing with outer diameters less than 4.0 mm to 5/16-24 threaded ports, reference the chart on page 43 to choose the correct nut/ferrule combination.

RELATED PRODUCTS

| | Page |
|---------------------------------|---------|
| MORE LARGE BORE PRODUCTS | |
| 5/16-24 Coned Fittings | 41 |
| Barbed Adapters | 92 |
| Threaded Adapters | 65 |
| Plugs | 57, 113 |
| Y Connector | 85 |
| ETFE Tubing | 27 |
| FEP, PFA Tubing | 26, 24 |
| Tubing Cutter | 28 |
| Pressure Relief Valve | 150 |
| Solvent Inlet Filters | 104 |
| Bottle Caps | 57 |
| Semi-Prep Inline Filters | 109 |

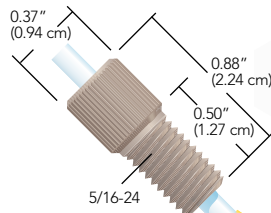

XP-130x
PEEK Nut, for 1/8" OD tubing shown with P-300 Flangeless Ferrule (page 43)

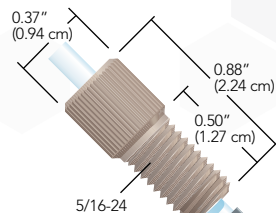

XP-131x
PEEK Nut, for 1/8" OD tubing shown with P-359 Super Flangeless™ Ferrule (included and found on page 41)

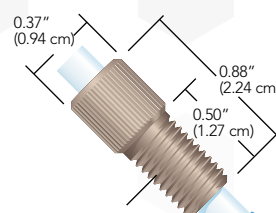

XP-132x
PEEK Nut, for 3/16" and 4.0 mm OD tubing shown with P-133 Flangeless Ferrule (included and found on this page)

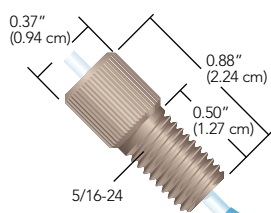

XP-136x
PEEK Nut, for 1/16" OD tubing shown with P-200 Flangeless Ferrule (included and found on page 43)

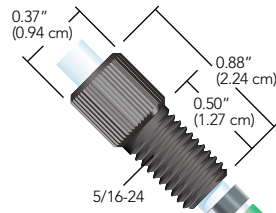

XP-137x
PEEK Nut, for 3/16" OD tubing shown with P-140 Super Flangeless Ferrule (included and found on page 58)

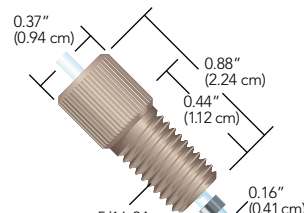

XP-141x
PEEK Nut, for 1/16" OD tubing shown with P-259 Super Flangeless Ferrule (included and found on page 41)

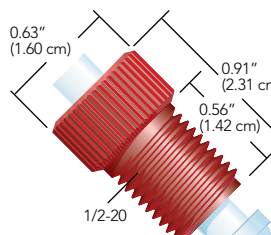

XU-620x
PEEK Nut, for 1/4" OD tubing shown with inverted U-650 Flangeless Ferrule for coned ports (included and found on this page)

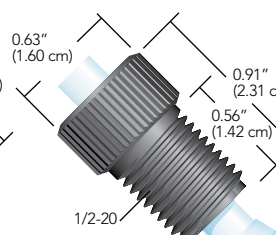

XU-655x
PEEK Nut, for 1/4" OD tubing shown with U-650 Flangeless Ferrule (included and found on this page)

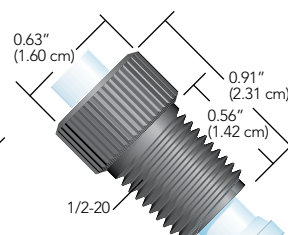

XU-662x
PEEK Nut, for 5/16" OD tubing shown with U-660 Flangeless Ferrule (included and found on this page)

| Part No. | Description | Port | Pressure Rating | Head Style | Material (Nut/Washer) | Qty. |
|-----------------------------|--|---------------------|---------------------|----------------|------------------------------|-------|
| LARGE BORE FITTINGS | | | | | | |
| XP-130x | Flangeless Fitting for 1/8" OD tubing | 5/16-24 Flat-Bottom | 500 psi (34 bar) | Standard Knurl | PEEK Natural/ETFE Yellow | 10-pk |
| XP-131x | Super Flangeless Fitting for 1/8" OD tubing | 5/16-24 Flat-Bottom | 1,000 psi (69 bar) | Standard Knurl | PEEK Natural/ETFE Yellow/SST | 10-pk |
| XP-132x | Flangeless Fitting for 3/16" OD tubing | 5/16-24 Flat-Bottom | 500 psi (34 bar) | Standard Knurl | PEEK Natural/ETFE Blue | 10-pk |
| XP-136x | Flangeless Fitting for 1/16" OD tubing | 5/16-24 Flat-Bottom | 2,000 psi (138 bar) | Standard Knurl | PEEK Natural/ETFE Blue | 10-pk |
| XP-137x | Super Flangeless Fitting for 3/16" OD tubing | 5/16-24 Flat-Bottom | 500 psi (34 bar) | Standard Knurl | PEEK Black/ETFE Green/SST | 10-pk |
| XP-141x | Super Flangeless Fitting for 1/16" OD tubing | 5/16-24 Flat-Bottom | 1,350 psi (93 bar) | Standard Knurl | PEEK Natural/ETFE Yellow/SST | 10-pk |
| XU-620x | Flangeless Fitting for 1/4" OD tubing | 1/2-20 Coned | 250 psi (17 bar) | Large Knurl | PEEK Red/ETFE Natural | 10-pk |
| XU-655x | Flangeless Fitting for 1/4" OD tubing | 1/2-20 Flat-Bottom | 250 psi (17 bar) | Large Knurl | PEEK Black/ETFE Natural | 10-pk |
| XU-662x | Flangeless Fitting for 5/16" OD tubing | 1/2-20 Flat-Bottom | 250 psi (17 bar) | Large Knurl | PEEK Black/ETFE Natural | 10-pk |
| REPLACEMENT FERRULES | | | | | | |
| P-133x | Flangeless Ferrule for 3/16" OD tubing | 5/16-24 Flat-Bottom | 500 psi (34 bar) | — | ETFE Blue | 10-pk |
| P-133Nx | Flangeless Ferrule for 3/16" OD tubing | 5/16-24 Flat-Bottom | 500 psi (34 bar) | — | ETFE Natural | 10-pk |
| P-140x | Super Flangeless Ferrule for 3/16" OD tubing | 5/16-24 Flat-Bottom | 500 psi (34 bar) | — | ETFE Green | 10-pk |
| U-650x | Flangeless Ferrule for 1/4" OD tubing | 1/2-20 Flat-Bottom | 250 psi (17 bar) | — | ETFE Natural | 10-pk |
| U-660x | Flangeless Ferrule for 5/16" OD tubing | 1/2-20 Flat-Bottom | 250 psi (17 bar) | — | ETFE Natural | 10-pk |

VHP Micro Fittings

Micro Fittings are specifically designed for use with microferrules. They are manufactured from a proprietary PEEK blend (PK) which allow them to be used at higher temperatures (up to 200° C) and higher pressures ideal for UHPLC applications.

VHP MicroFerrules and Fittings are made from a proprietary high performance PEEK polymer blend, a material which is unique in its ability to enable the use of capillary tubing in UHPLC environments. The new high pressure MicroFerrules are available for use with 1/32" or 360 µm OD tubing, and they are incorporated into several of our VHP products for capillary tubing.

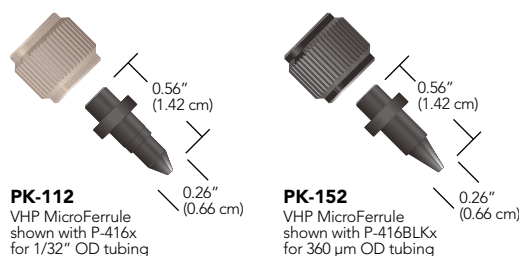

APPLICATION NOTE

Caution: While the proprietary blend of the PK fittings will allow a fitting to attain a higher pressure and minimal cold flow properties relative to pure PEEK, some fittings molded of PK are known to be conductive. Use caution when employing PK fittings in high voltage applications.



NOTE

MicroTight fittings and MicroFerrules

While the MicroTight Female Nuts may be used with any of the separate MicroFerrules, the MicroFerrules themselves are port-specific and are thus not interchangeable. Additionally, the one-piece MicroTight fittings are also port-specific and should not be exchanged.

| Part No. | Description | Port | Pressure Rating | Required Torque | Head Style | Material | Qty. |
|--|---------------------------------------|---------------|------------------------|-----------------------|--------------|---------------|------|
| PK MICRO FERRULES AND FEMALE NUTS | | | | | | | |
| P-416 | Female Nut for Microferrule | 5/16-24 Coned | 15,000 psi (1,035 bar) | 4.0 in-lbs (0.45 N-m) | Female Knurl | PEEK, Natural | ea. |
| P-416BLK | Female Nut for Microferrule | 5/16-24 Coned | 15,000 psi (1,035 bar) | 4.0 in-lbs (0.45 N-m) | Female Knurl | PEEK, Black | ea. |
| PK-112 | VHP MicroFerrule for 1/32" OD Tubing | 5/16-24 Coned | 15,000 psi (1,035 bar) | — | — | PK | ea. |
| PK-152 | VHP MicroFerrule for 360 µm OD Tubing | 5/16-24 Coned | 15,000 psi (1,035 bar) | — | — | PK | ea. |



VHP PK Fittings

RELATED PRODUCTS

- Find unions, tees and crosses for VHP applications on page 76.

Ultra High Performance fittings are manufactured from a proprietary PEEK blend (PK) which allow them to be used at higher temperatures (up to 200 °C) and higher pressures.

The VHP PK One-Piece fittings are available for 10-32 coned, 6-32 coned, or M4 coned ports, and Two-Piece fittings are available to connect either 1/16" or 1/32" OD tubing in multiple styles.

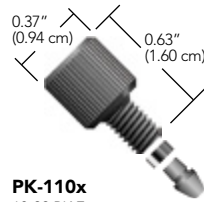

PK-110x
10-32 PK Fitting
shown with PK-100x for
1/16" OD tubing

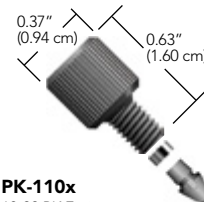

PK-110x
10-32 PK Fitting
shown with PK-132x for
1/32" OD tubing

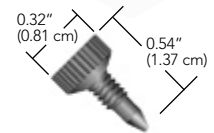

PK-126x
6-32 PK MicroTight® Fitting
for 1/32" OD tubing

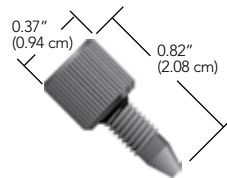

PK-120BLKx
10-32 PK Fitting
for 1/16" OD tubing

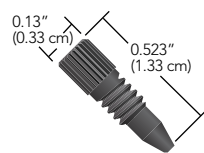

PK-126Hx
6-32 PK MicroTight® Fitting
for 1/32" OD tubing

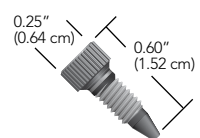

UH-904x
M4, 1/32" Fitting
for IDEX Health & Science
MX valves

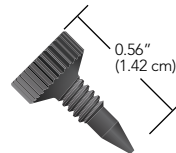

PK-124x
6-32 PK MicroTight® Fitting
for 1/32" OD tubing

| Part No. | Description | Port | Pressure Rating | Required Torque | Head Style | Material | Qty. |
|--|---|-------------|------------------------|-----------------------|----------------------|----------|-------|
| PK VHP ONE-PIECE FITTINGS | | | | | | | |
| PK-120BLKx | PK One-Piece Fitting for 1/16" OD Tubing | 10-32 Coned | 12,000 psi (827 bar) | 8.0 in-lbs (0.90 N-m) | Standard Knurl | PK | 10-pk |
| PK-126Hx | PK One-Piece Headless Fitting for 1/32" OD Tubing | 6-32 Coned | 15,000 psi (1,035 bar) | 3.0 in-lbs (0.34 N-m) | Headless Micro Knurl | PK | 10-pk |
| PK-126x | PK One-Piece Fitting for 1/32" OD Tubing | 6-32 Coned | 15,000 psi (1,035 bar) | 3.0 in-lbs (0.34 N-m) | Standard Micro Knurl | PK | 10-pk |
| UH-904x | PK One-Piece Fitting for 1/32" OD Tubing | M4 Coned | 15,000 psi (1,035 bar) | 4.0 in-lbs (0.45 N-m) | Headless Knurl | PK | 10-pk |
| PK VHP FITTINGS (LITETOUGH® STYLE, NUTS AND FERRULES SOLD SEPARATELY) | | | | | | | |
| PK-100x | PK Ferrule for 1/16" OD Tubing | 10-32 Coned | 16,500 psi (1,140 bar) | — | — | PK | 10-pk |
| PK-110x | PK Nut for 1/16" OD Tubing | 10-32 Coned | 16,500 psi (1,140 bar) | 8.0 in-lbs (0.90 N-m) | Standard Knurl | PK | 10-pk |
| PK-132x | PK Ferrule for 1/32" OD Tubing | 10-32 Coned | 16,500 psi (1,140 bar) | — | — | PK | 10-pk |

Stainless Steel VHP Fittings

- › Pressure rated to 30,000 psi (2,070 bar)
- › Double compression ferrule design
- › Available with 10-32 threads for 1/16" OD tubing and M4 threads for 1/32" OD tubing

The all Stainless-Steel VHP Fittings include a unique ferrule system with two compression points to provide twice the grip of a standard ferrule. This design also allows the bite on the tubing to be less concentrated and does not restrict the inner diameter, as discussed in the Application Note. The ferrules for 1/16" OD tubing and 10-32 coned ports are two pieces, while the grooved ferrule for 1/32" OD tubing and M4 coned ports is a one-piece design for easier handling, but it will act as two pieces with double compression on the tubing as it is tightened down.



APPLICATION NOTE

In order to seal up to the stated pressure rating, the VHP-200-01 ferrule requires 20 in-lbs (2.25 N·m) of torque. Similar ferrules on the market require tightening torque of at least 30 in-lbs (3.3 N·m), which can result in a restricted tubing passage, as shown in the picture below. This restriction can increase turbulence and add a 'throttling' effect to the fluid pathway, resulting in mixing and other potential chromatographic problems.

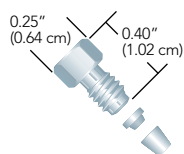

VHP-200x
VHP 10-32 Fitting
for 1/16" OD tubing

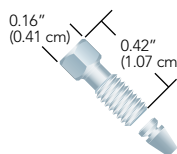

VHP-700x
VHP 6-40 Fitting
for 1/32" OD tubing

IDEX Health & Science VHP-200

Conventional Two Piece Ferrule Design

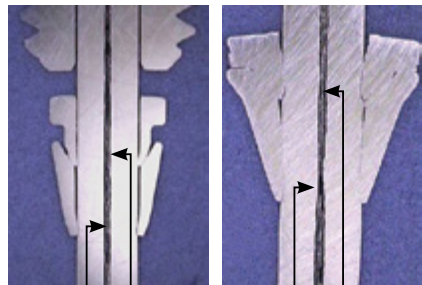

Uniform
Tubing Passage

Constricted
Tubing Passage

| Part No. | Description | Port | Pressure Rating | Required Torque | Head Style | Material | Qty. |
|--|--------------------------|-------------|------------------------|----------------------|------------|----------|-------|
| STAINLESS STEEL VHP FITTINGS (INCLUDES NUT AND FERRULE) | | | | | | | |
| VHP-200x | VHP Fitting for 1/16" OD | 10-32 Coned | 30,000 psi (2,070 bar) | 20 in-lbs (2.25 N·m) | 1/4" Hex | SST | 10-pk |
| VHP-700x | VHP Fitting for 1/32" OD | 6-40 Coned | 30,000 psi (2,070 bar) | 20 in-lbs (2.25 N·m) | 4 mm Hex | SST | 10-pk |
| STAINLESS STEEL VHP FERRULES | | | | | | | |
| VHP-200-01x | VHP Ferrule for 1/16" OD | 10-32 Coned | 30,000 psi (2,070 bar) | 20 in-lbs (2.25 N·m) | — | SST | 10-pk |



Reusable VHP Fittings

- › Pressure rated up to 25,000 psi (1,720 bar)
- › Patented innovative design
- › Capable of up to ten repeat assembly cycles with no impact on pressure holding ability or carry-over
- › Available in 10-32 threads for 1/16" OD tubing and M4 threads for 1/32" OD tubing
- › Materials of construction: stainless steel and proprietary PEEK polymer blend (PK)
- › Quick component replacement, minimal downtime



RELATED PRODUCTS

- › Find tightening tools on page 52 designed to deliver the torque necessary for these fittings.

IDEX Health & Science introduces an innovative line of Very High Pressure (VHP) fittings, designed to withstand extreme pressures. This patented line of ground-breaking fitting systems is perfect for use within the increasingly demanding requirements of today's high performance analytical systems.

The Reusable VHP fittings can be reused when following the tightening torque specification listed below. With a polymer front ferrule, there is no damage to the tubing or receiving port, also increasing the life of these components.

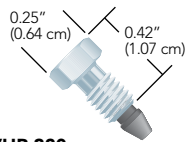

VHP-320x
10-32 VHP Fitting
for 1/16" OD tubing

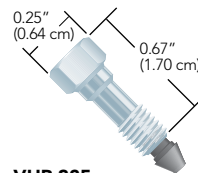

VHP-325x
10-32 VHP Fitting, Long
for 1/16" OD tubing

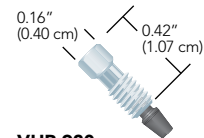

VHP-920x
M4 VHP Fitting
for 1/32" OD tubing

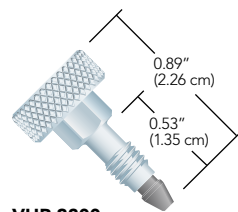

VHP-3200x
10-32 VHP Fitting
for 1/16" OD tubing

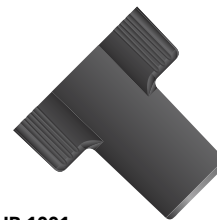

VHP-1001
VHP Fingertight
1/4" Hex Tool

| Part No. | Description | Port | Pressure Rating | Required Torque | Head Style | Material | Qty. |
|------------------------------|--------------------------------|-------------|------------------------|-----------------------|------------|----------|-------|
| REUSABLE VHP FITTINGS | | | | | | | |
| VHP-320x | VHP Fitting for 1/16" OD | 10-32 Coned | 25,000 psi (1,720 bar) | 10 in-lbs (1.10 N-m) | 1/4" Hex | SST/PK | 10-pk |
| VHP-325x | VHP Fitting for 1/16" OD, Long | 10-32 Coned | 25,000 psi (1,720 bar) | 10 in-lbs (1.10 N-m) | 1/4" Hex | SST/PK | 10-pk |
| VHP-920x | VHP Fitting for 1/32" OD | M4 Coned | 25,000 psi (1,720 bar) | 8 in-lbs (0.90 N-m) | 4 mm Hex | SST/PK | 10-pk |
| VHP-3200x | VHP Fitting for 1/16" OD | 10-32 Coned | 11,000 psi (760 bar) | 3.5 in-lbs (0.40 N-m) | 1/2" Knurl | SST/PK | 10-pk |
| VHP-1001 | VHP Fingertight 1/4" Hex Tool | — | — | — | — | PPS | ea. |

Assorted Fittings Kits

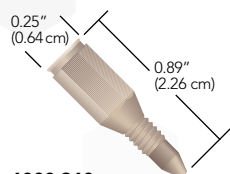

6000-360
M4 Fitting
M4 threads
for 1/32" OD tubing

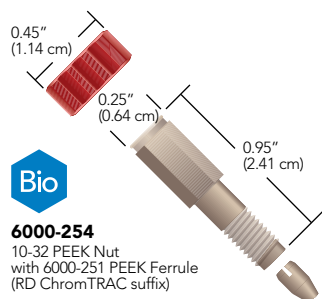

6000-254
10-32 PEEK Nut
with 6000-251 PEEK Ferrule
(RD ChromTRAC suffix)

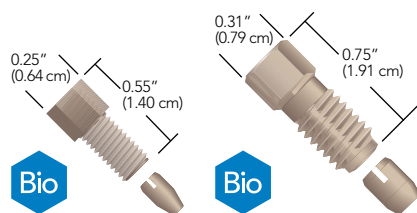

6000-255
10-32 PEEK Nut
with 6000-251 PEEK Ferrule

6000-078
5/16-24 PEEK Nut
with 6000-079 PEEK Ferrule

RheFlex® M4 Fittings

- › Incorporates M4 coned threads for 1/32" OD tubing
- › Pressure rated to 5,000 psi (345 bar)

Our RheFlex M4 Fitting is designed to connect 1/32" OD tubing in MX Series II™ valves (see Actuated Valves, starting on page 121). This PEEK fitting has a one piece design, which eliminates the need for a separate nut and ferrule. The M4 Fitting design provides dependable zero dead volume connections for micro and nano applications. Due to the unique RheFlex gripping design, the M4 Fitting will hold to 5,000 psi (345 bar) on PEEK or with a PEEK tubing sleeve on fused silica tubing. A PEEK M4 Plug is also available.

Use ChromTRAC™ knobs with the RheFlex M4 Fitting for fingertight convenience and to color-code connections.

Two-Piece RheFlex Fingertight Fittings

The RheFlex Precision Two-Piece PEEK Fittings sets provide inert, biocompatible connections for instrumentation. These fittings have a reliable, time-tested design. Each 1/16" fittings set contains a 10-32 threaded nut and a specially-designed PEEK ferrule. Three lengths of the 1/16" nut are available: Standard, Short, and Extra Long. RheFlex Fingertight Fittings are rated for use up to 7,000 psi (483 bar). Also offered in this product line is the 6000-078 fitting, designed to connect 1/8" OD tubing into our manual preparative-scale injection valves. (See page 117 for more information on these valves.) *View the online product bulletin at: www.idex-hs.com.*

ChromTRAC™

- › Brightly colored knobs to easily track inlets and outlets of valves, columns, and detectors

All ChromTRAC-compatible RheFlex fittings offer the ChromTRAC knob option. Specify the ChromTRAC two letter suffix for the color choice when ordering. Please see the ChromTRAC Suffix Codes table below. For example, to order red ChromTRAC knobs with the RheFlex One-Piece Fitting on this page, specify 6000-282RD. No suffix indicates black knobs. *View the online product bulletin for RheFlex fittings at: www.idex-hs.com.*

ChromTRAC Suffix Codes

| CODE | COLOR | CODE | COLOR |
|------|-------|------|--|
| BL | Blue | WH | White |
| GN | Green | YL | Yellow |
| GY | Gray | MC | Multi-color (two each of blue, green, gray, red, and yellow) |
| RD | Red | | |

Add these letter suffixes to the end of the seven-digit part numbers of the 10-32 and M4 threaded RheFlex Fittings listed below.

RELATED PRODUCTS

- › For PEEK tubing sleeves that can be used with these M4 RheFlex fittings, see page 54.
- › For reusable fittings that both work in UHPLC applications and can help ensure the tubing is fully inserted into the receiving port, see page 62.

| Part No. | Description | Port | Pressure Rating | Head Style | Material | Qty. |
|---|--|---------------|---------------------|----------------|---------------|-------|
| RHEFLEX ONE-PIECE FITTINGS | | | | | | |
| 6000-360 | RheFlex Fitting for 1/32" OD Tubing | M4 Coned | 5,000 (345 bar) | 1/4" Hex | PEEK, Natural | 10-pk |
| RHEFLEX TWO-PIECE FITTINGS (INCLUDES FERRULES) | | | | | | |
| 6000-078 | RheFlex Fitting for 1/8" OD Tubing | 5/16-24 Coned | 5,000 psi (345 bar) | 5/16" Hex | PEEK, Natural | ea. |
| 6000-254 | RheFlex Fitting for 1/16" OD Tubing | 10-32 Coned | 7,000 psi (483 bar) | ChromTRAC knob | PEEK, Natural | 10-pk |
| 6000-255 | RheFlex Fitting for 1/16" OD Tubing, Short | 10-32 Coned | 7,000 psi (483 bar) | 1/4" Hex | PEEK, Natural | 10-pk |
| REPLACEMENT FERRULES | | | | | | |
| 6000-079 | RheFlex Ferrule for 1/8" OD Tubing | 5/16-24 Coned | 7,000 psi (483 bar) | ChromTRAC knob | PEEK, Natural | 5-pk |
| 6000-251 | RheFlex Ferrule for 1/16" OD Tubing | 10-32 Coned | 7,000 psi (483 bar) | ChromTRAC knob | PEEK, Natural | 10-pk |

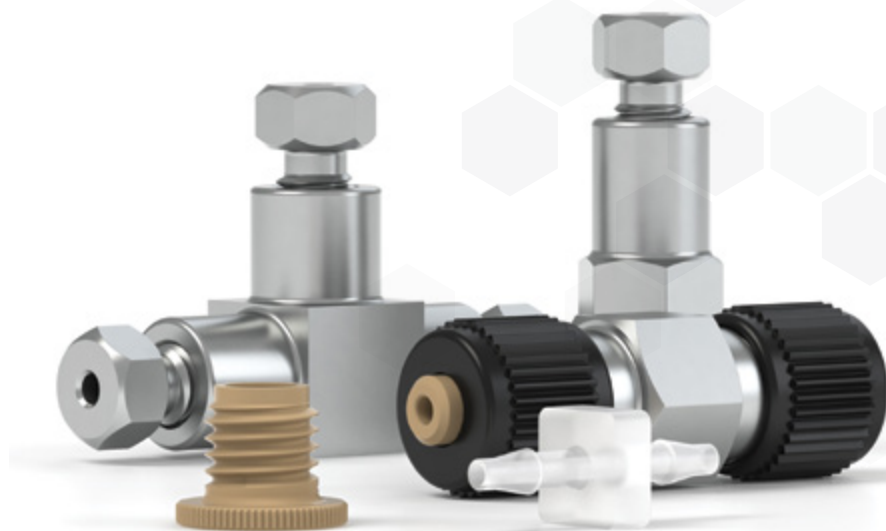

CONNECTORS

Connectors are designed to securely join tubing together or to facilitate the joining of tubing to other fluid pathway components. We offer multiport connectors with different thread and port configurations to meet your system requirements and connection needs. Some of our connectors feature a True ZDV (Zero Dead Volume) internal configuration that helps minimize the formation of dead volume in your fluidic pathway. Our versatile adapters help bring two connectors with different configurations together. Connectors are manufactured from 316 stainless steel or from inert polymers to ensure chemical compatibility with the fluid passing through. Peristaltic tube connectors are ideal for making connections with soft-walled, peristaltic tubing. Our extensive line of connectors includes tees, crosses, Luer Adapters, barbed and threaded adapters, and a variety of other options.

| | | | |
|-----------|---|-----------|--|
| 65 | THREADED ADAPTERS | 81 | ACCESSORIES |
| 69 | HIGH PRESSURE MULTIPORT CONNECTORS | 82 | NANOPORT ASSEMBLIES |
| 74 | ULTRA HIGH PRESSURE MULTIPORT CONNECTORS | 83 | LOW PRESSURE MULTIPORT CONNECTORS |
| 79 | MICROTIGHT® ADAPTERS | 92 | LUER ADAPTERS |
| | | 93 | PERISTALTIC TUBE CONNECTORS |

Distributed By

Fiedler
Scientific
Instruments

info@pristroje.cz

info@lab-eu.com

(+420) 541 222 795